

一月
January

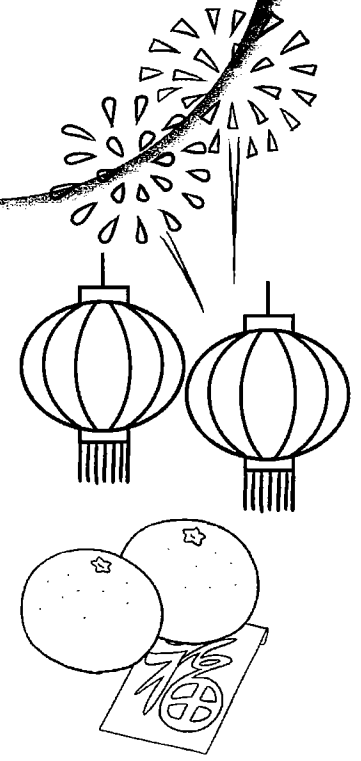
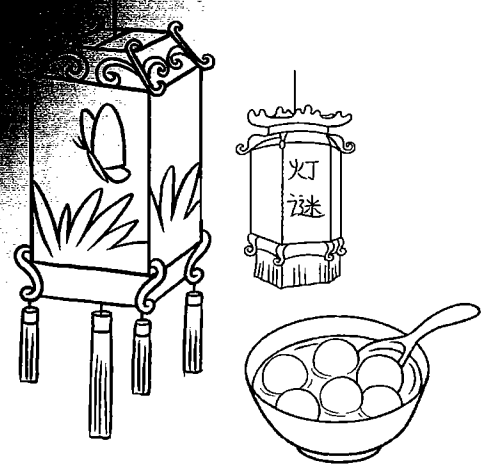

Calendar

一月月历

Zodiac Animals

十二生肖

Chinese New Year
(Spring Festival)

农历新年
(春节)

Lantern Festival

元宵节

Try It Out!

每月一练

Let's Talk!

说一说

Let's Write!

写一写



shí

十

èr

二

shēng

生

xiào

肖

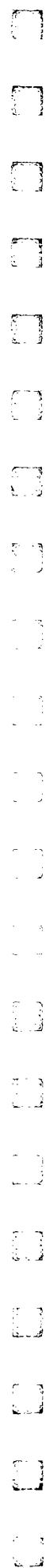
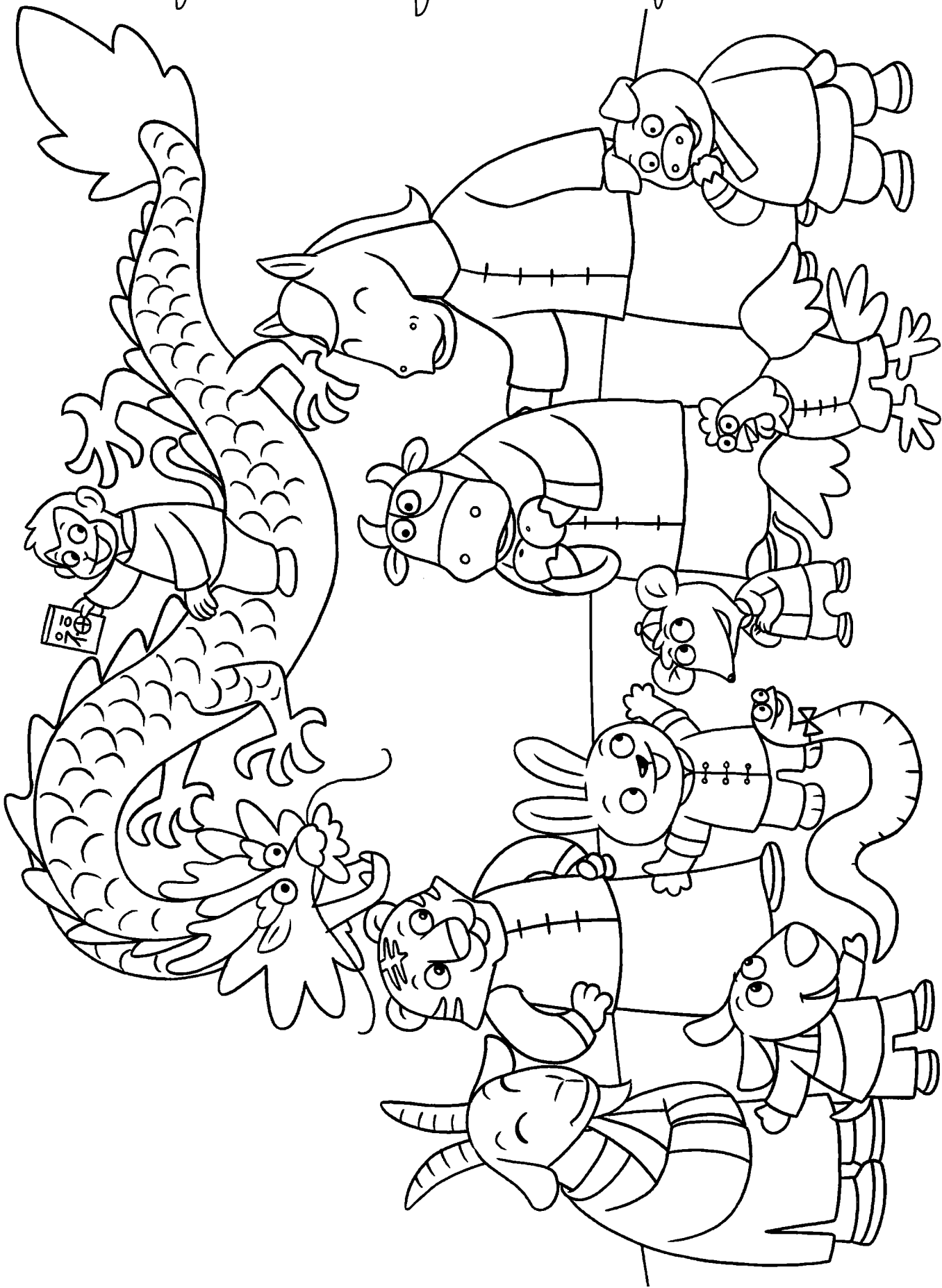

What's Happening in January?
一月知多少?

1. jīn tiān shì _____ yuè _____ rì 。
今天 是 _____ 月 _____ 日。

2. míng tiān shì _____ yuè _____ rì 。
明天 是 _____ 月 _____ 日。

3. zuó tiān shì _____ yuè _____ rì 。
昨天 是 _____ 月 _____ 日。

4. jīn tiān shì xīng qī _____ 。
今天 是 星期 _____。

5. yī yuè yǒu _____ tiān 。
一月 有 _____ 天。

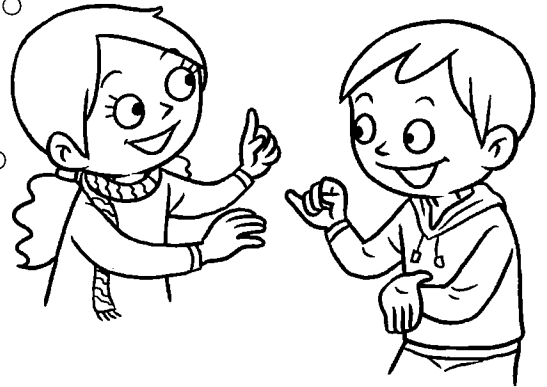

6. yī yuè zhōng tè bié de rì zi shì _____ 。
一月中 特别 的日子 是 _____。

7. xīn nián shì _____ yuè _____ rì 。
新年 是 _____ 月 _____ 日。

8. yī yuè de dì yí gè xīng qī wǔ shì _____ yuè _____ rì 。
一月的 第一个 星期五 是 _____ 月 _____ 日。

9. yī yuè de zuì hòu yí gè xīng qī yī shì _____ yuè _____ rì 。
一月的 最后 一个 星期一 是 _____ 月 _____ 日。

10. _____ de shēng rì shì _____ yuè _____ rì 。
(a person's name) 的生日 是 _____ 月 _____ 日。

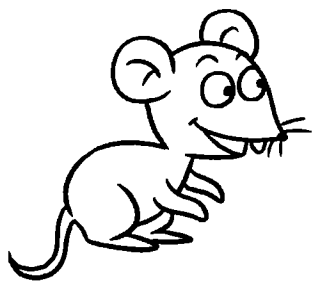

shǔ lǎo shǔ
鼠 / 老鼠

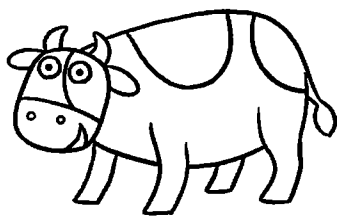

niú
牛



hǔ lǎo hǔ
虎 / 老虎

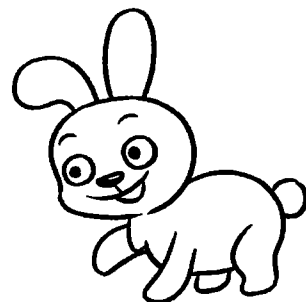

tù tù zi
兔 / 兔子



lóng
龙

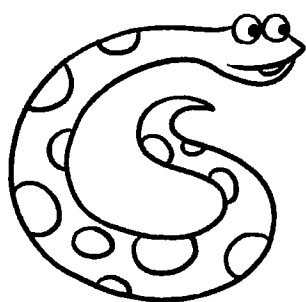

shé
蛇

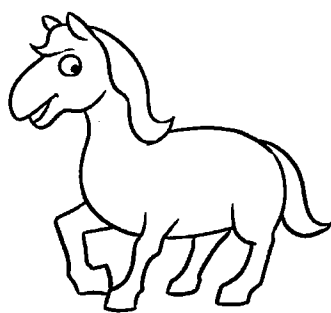

mǎ
马

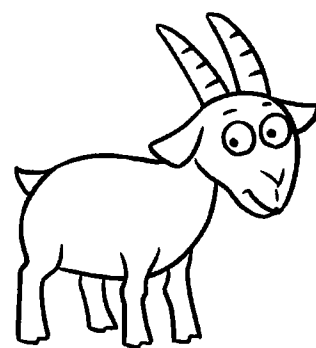

yáng
羊

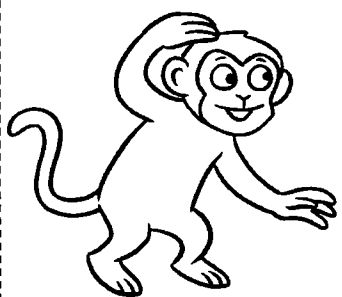

hóu hóu zi
猴 / 猴子

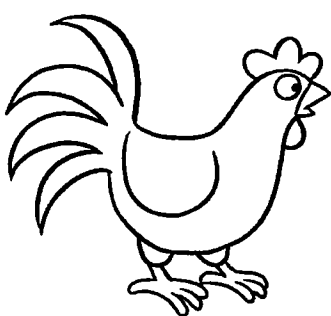

jī
鸡

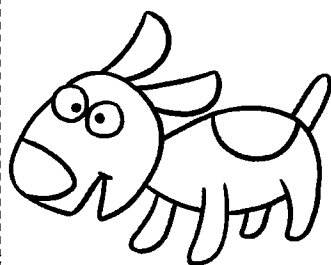

gǒu
狗

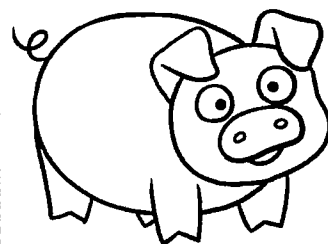



zhū
猪

Find and Color: Who Are the Winners?
找一找，涂一涂：谁赢了？

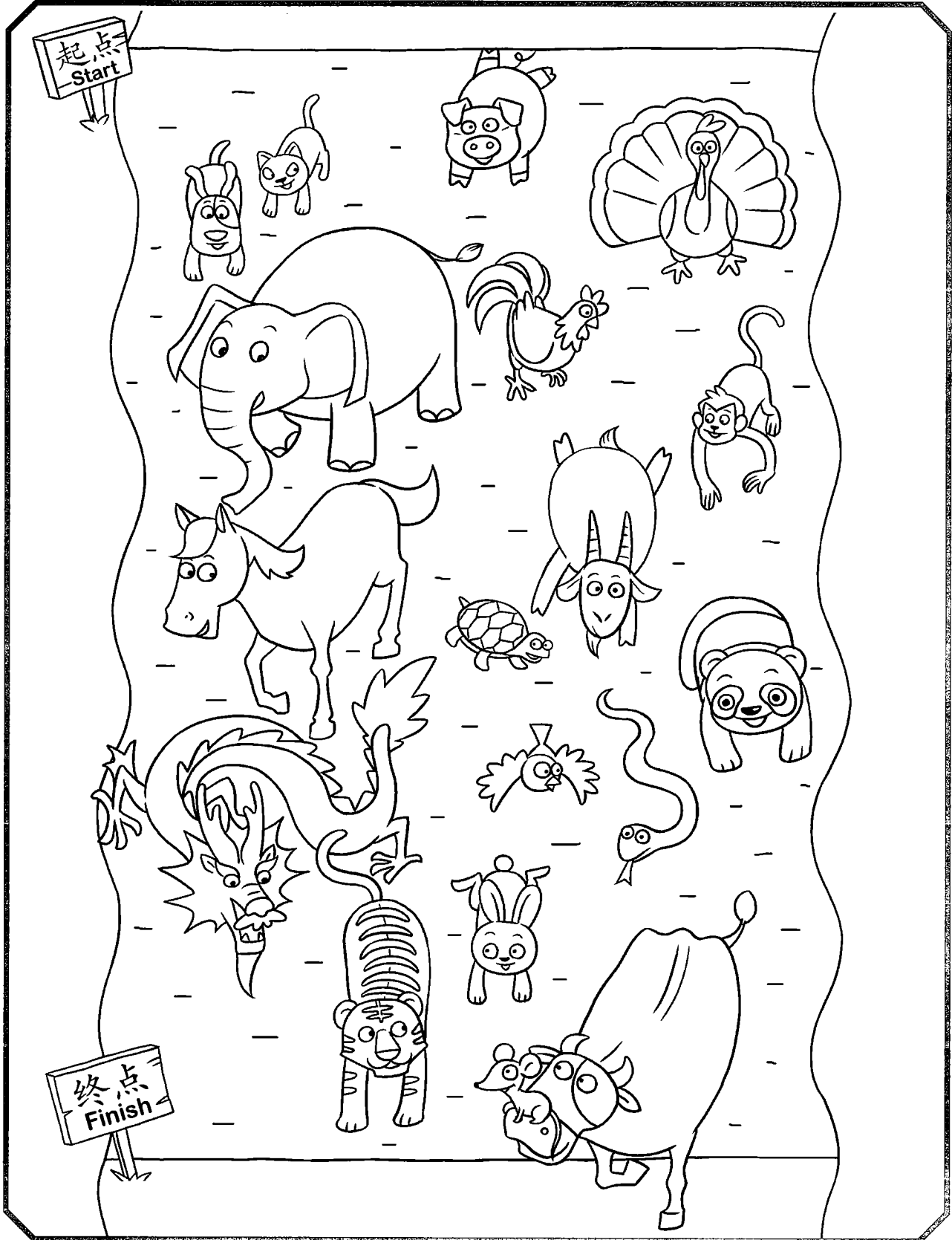
The emperor announced, "The first 12 animals to reach the finish line will have a year named after them!" Color the 12 animals that are the winners in the race.

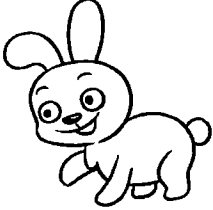

Cut and Paste: What Is the Next Zodiac Animal?
剪一剪，贴一贴：下一个生肖是什么？

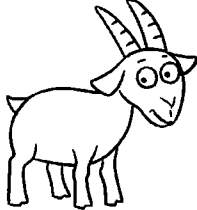
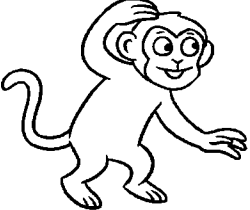
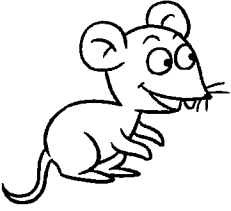
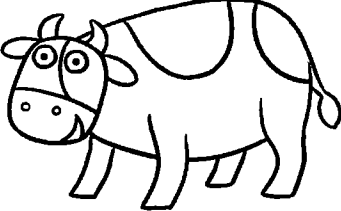



Year 1999  tù zi 兔子	Year 2000  lóng 龙	Year 2001
Year 2003  yáng 羊	Year 2004  hóu zi 猴子	Year 2005
Year 2008  lǎo shǔ 老鼠	Year 2009  niú 牛	Year 2010

 jī 鸡	 lǎo hǔ 老虎	 shé 蛇
--	---	---

名字： _____ 月 _____ 日

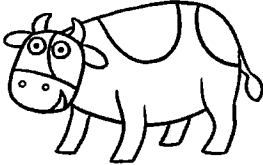
Matching Activity: Zodiac Animal Matching
配对游戏：生肖配一配

Cut out the pinyin words and Chinese characters below. Paste each next to its animal picture.

	Pinyin	Chinese Character
		
		
		
		
		
		

lǎo shǔ	lóng	mǎ	gǒu	yáng	niú
老鼠	龙	羊	狗	马	牛



Compare: Are They the Same or Different?

说一说，比一比：它们哪里相同？哪里不同？

Say the names of the following animals. Then compare each pair of animals listed below and point out their similarities and differences. The first one has been done for you. For the last question, fill in any two animals and compare them.

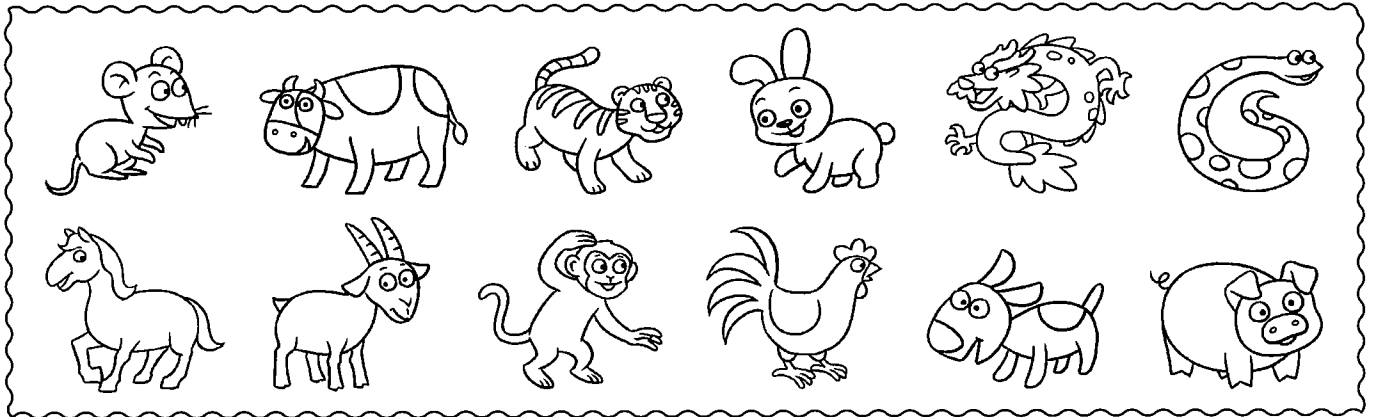

1. 牛和羊： 牛和羊都有四只脚、都吃草、颜色不同。

2. 龙和蛇： _____

3. 鸡和兔： _____

4. 老虎和猴子： _____

5. 老鼠和牛： _____

6. _____ : _____

Bonus: Can you use two zodiac animals to make up a Chinese idiom?

Hint: Try an online search of "Chinese idioms".

(For example: jī fēi gǒu tiào 鸡飞狗跳)

1. _____ 2. _____

Vocabulary Review: Who Am I?
词汇练习：我是谁？

Fill in the blanks.

<p>wǒ shuō wō wō wō 1. 我说：“喔喔喔……” (I say, "Cockle doodle doo.")</p>	<p>wǒ shì _____。</p>
<p>māo ài zhuī wǒ 2. 猫爱追我。 (Cats love to chase me.)</p>	<p>我是_____。</p>
<p>wǒ huì fēi 3. 我会飞。 (I can fly in the sky.)</p>	<p>我是_____。</p>
<p>wǒ huì pá shān 4. 我会爬山。 (I can climb mountains.)</p>	<p>我是_____。</p>
<p>wǒ de bèi ràng rén qí 5. 我的背让人骑。 (People love to ride on my back.)</p>	<p>我是_____。</p>
<p>wǒ ài shuì jiào 6. 我爱睡觉。 (I love to sleep.)</p>	<p>我是_____。</p>
<p>wǒ jiào sī sī sī 7. 我叫：“嘶嘶嘶……” (I say, "ssssssssss.")</p>	<p>我是_____。</p>
<p>wǒ ài chī hú luó bo 8. 我爱吃胡萝卜。 (I love to eat carrots.)</p>	<p>我是_____。</p>
<p>wǒ shuō miē miē miē 9. 我说：“咩咩咩……” (I say, "Baa baa.")</p>	<p>我是_____。</p>
<p>wǒ jiào wāng wāng wāng 10. 我叫：“汪汪汪……” (I say, "Woof, woof.")</p>	<p>我是_____。</p>
<p>wǒ shuō mōu mōu mōu 11. 我说：“哞哞哞……” (I say, "Moo, moo.")</p>	<p>我是_____。</p>
<p>wǒ ài chī xiāng jiāo 12. 我爱吃香蕉。 (I love to eat bananas.)</p>	<p>我是_____。</p>



它们能(会)做什么?
What Can These Animals Do?

tā men néng huì zuò shén me

名字: _____



jiào 叫

tiào 跳

pǎo 跑

二



chī 吃

fēi 飞

pá 爬

三

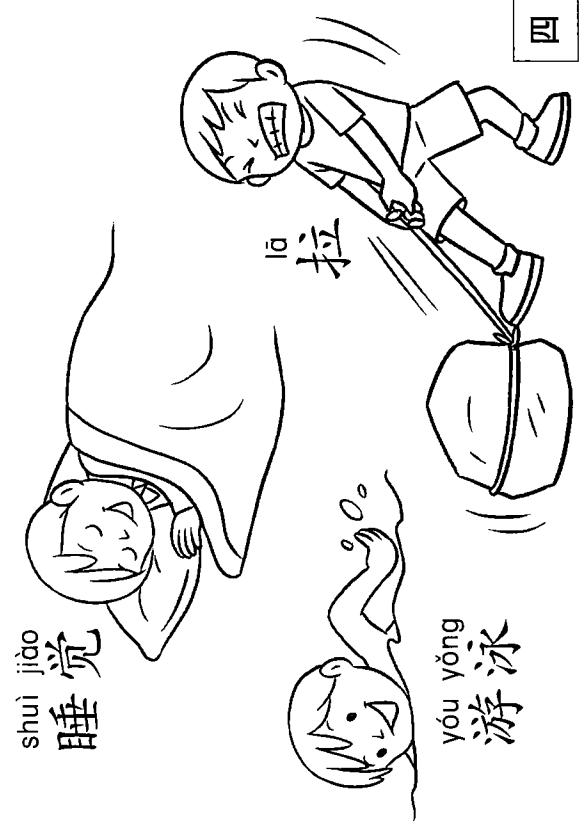

shuì jiào 睡觉

yóu yǒng 游泳

lā 拉

四



shǔ
鼠 (Rat)

lǎo shǔ ài rǔ lào
老鼠爱乳酪。
The rat loves to eat cheese.

五

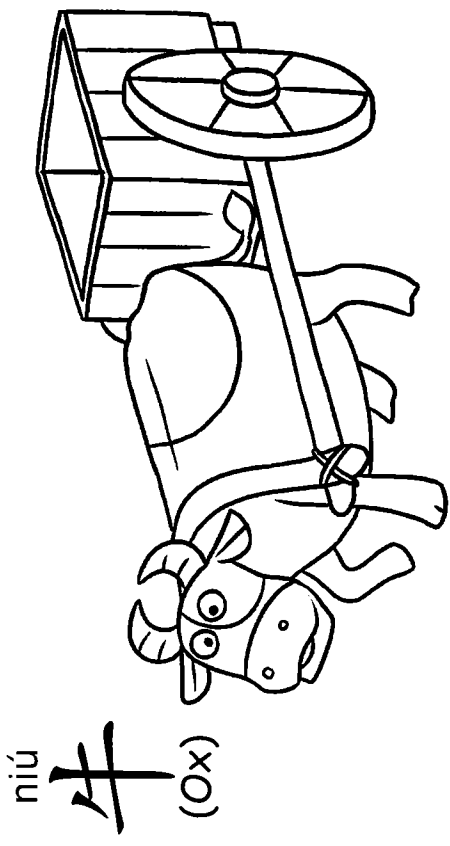

niú
牛 (Ox)

niú huì chē
牛会车。
The ox can pull a cart.

六

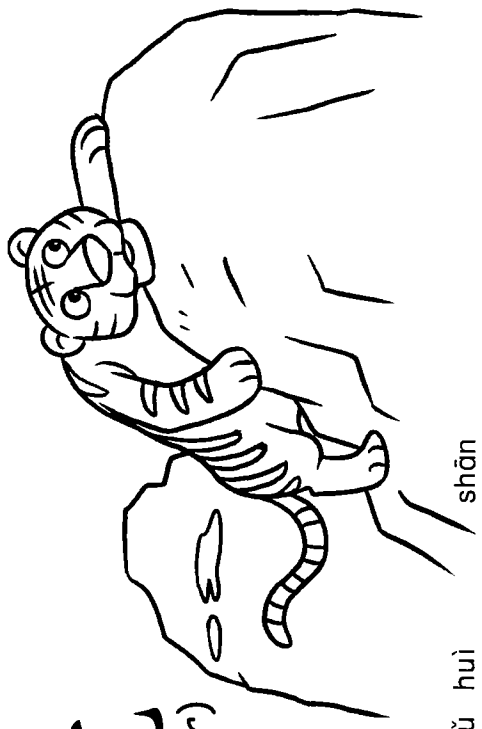

hǔ
虎 (Tiger)

lǎo hǔ huì shān
老虎会山。
The tiger can climb mountains.

七

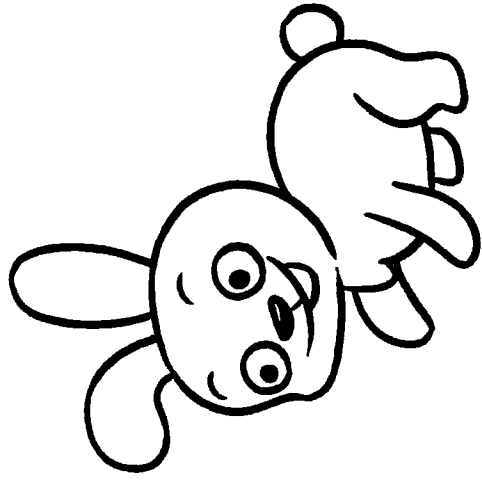

tù
兔 (Rabbit)

tù zi huì
兔子会。
The rabbit can jump.

八

Note: Besides "乳酪", "cheese" is also known as "芝士".

lóng

龙
(Dragon)



lóng huì

龙会——。○
The dragon can fly.

九

shé

蛇
(Snake)

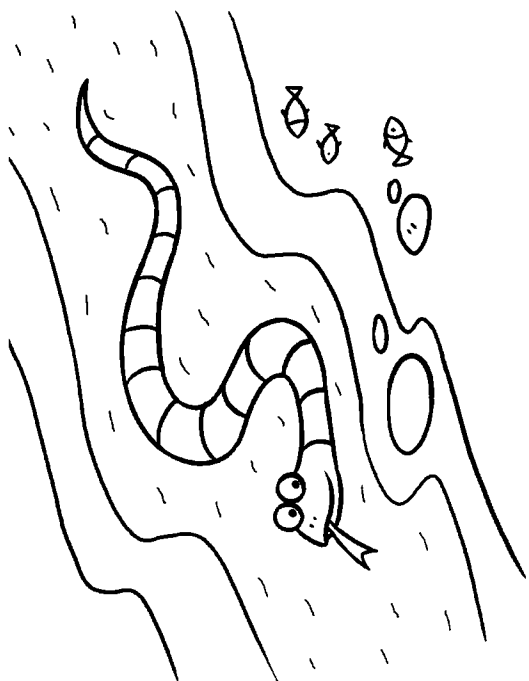

shé huì

蛇会——。○
The snake can swim.

十

mǎ

马
(Horse)



mǎ huì

马会——。○
The horse can run.

十一

yáng

羊
(Goat)



yáng ài cǎo

羊爱——草。○
The goat loves to eat grass.

十二



hóu zi
猴子
(Monkey)

hóu zi huì shù shù。
猴子会 树。
The monkey can climb trees.

十三

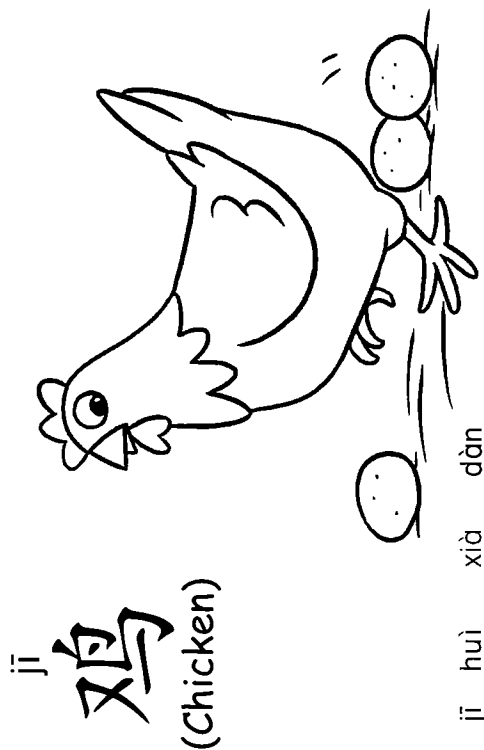

jī
鸡
(Chicken)

jī huì xià dàn。
鸡会 下蛋。
The hen can lay eggs.

十四



gǒu
狗
(Dog)

gǒu huì 。
狗会 。
The dog can bark.

十五

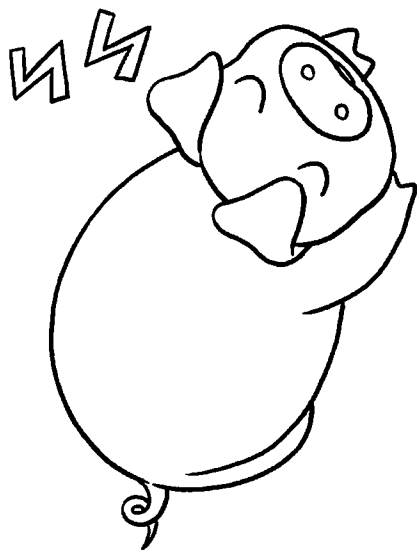

zhū
猪
(Pig)

zhū ài 。
猪爱 。
The pig loves to sleep.

十六

Reading: Chinese Zodiac Personality Traits
读一读：你的生肖个性

 <p>shǔ 鼠</p> <p>1960, 1972, 1996, 2008 You are very popular. You are good at art and like to invent things.</p>	 <p>niú 牛</p> <p>1961, 1973, 1997, 2009 You are hardworking and patient. You are a good listener and have very strong ideas.</p>	 <p>hǔ 虎</p> <p>1962, 1974, 1998, 2010 You are brave and sensitive. People respect you for your deep thoughts and brave actions.</p>
 <p>tù 兔</p> <p>1963, 1975, 1999, 2011 You are talented and loving. You like to talk, and many people trust you.</p>	 <p>lóng 龙</p> <p>1964, 1976, 2000, 2012 You are proud and energetic. You have good health and lots of energy.</p>	 <p>shé 蛇</p> <p>1965, 1977, 1989, 2001 You are wise and good looking. You love good books, food, music, and art. You will have good luck with money.</p>
 <p>mǎ 马</p> <p>1966, 1978, 1990, 2002 You are cheerful and efficient. You like to compliment others.</p>	 <p>yáng 羊</p> <p>1967, 1979, 1991, 2003 You are kind and artistic. You are very friendly.</p>	 <p>hóu 猴</p> <p>1968, 1980, 1992, 2004 You are very wise and funny. You can always make people laugh. You are also very good at solving problems.</p>
 <p>jī 鸡</p> <p>1969, 1981, 1993, 2005 You are very honest and hardworking. You have many talents.</p>	 <p>gǒu 狗</p> <p>1970, 1982, 1994, 2006 You are loyal and honest. You can always keep secrets. Sometimes you worry too much.</p>	 <p>zhū 猪</p> <p>1971, 1983, 1995, 2007 You are fortunate and sincere. You are a good student. You always finish projects or assignments on time.</p>

Writing Activity: What Zodiac Animal Sign Do They Have?
写一写: 他们属什么生肖?

Complete the wheel by filling in one or two personality traits represented by each zodiac animal sign. You may refer to the chart on page 87.

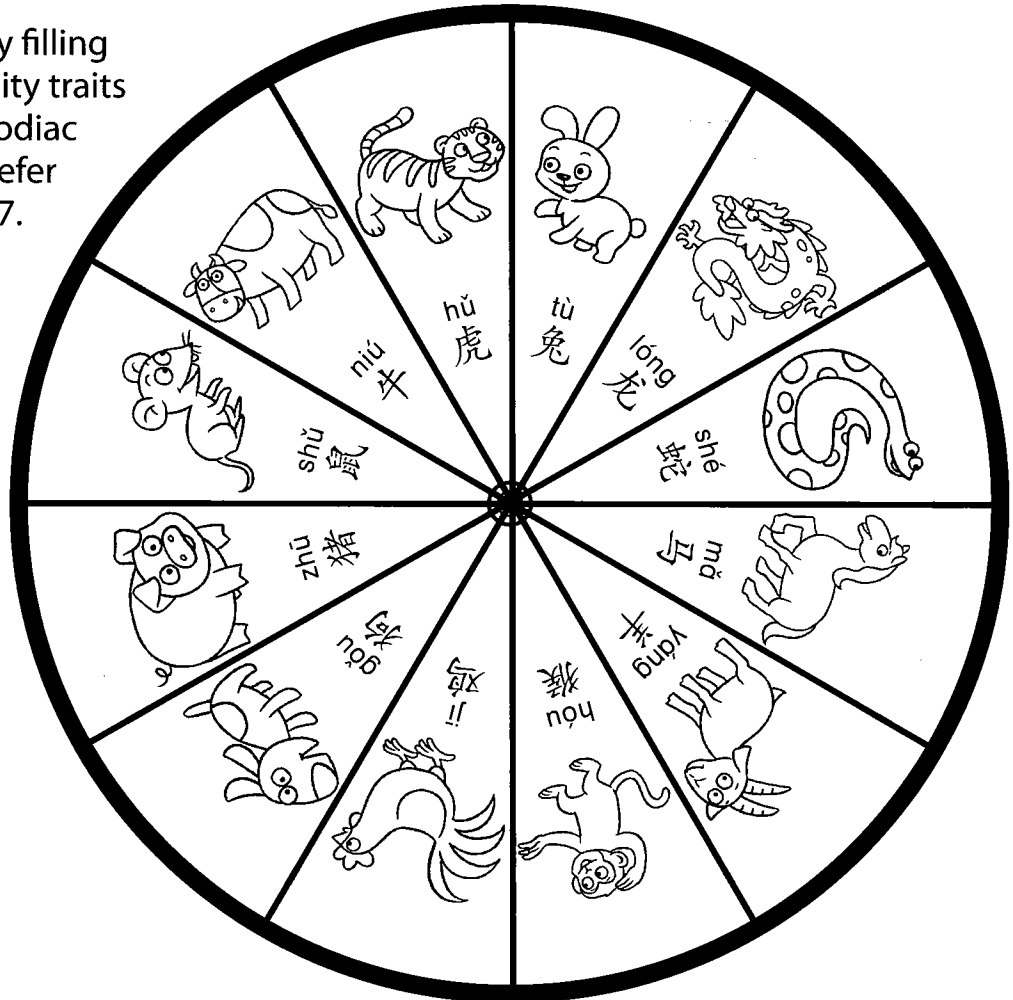

What zodiac animal sign do your family and friends have? Fill in the blanks.

1. I was born in the Year of the _____.
I am very _____.
2. My _____ was born in the Year of the _____.
He/She is very _____ and _____.
3. My _____ was born in the Year of the _____.
He/She is very _____ and _____.
4. My _____ was born in the Year of the _____.
He/She is very _____ and _____.

Word Search: Zodiac Animals ①

找一找：生肖 ●

Write the animal names in English:

- | | | | |
|----------------|-------|----------------|-------|
| 1. 猪 zhū: | _____ | 7. 牛 niú: | _____ |
| 2. 老虎 lǎo hǔ: | _____ | 8. 蛇 shé: | _____ |
| 3. 鸡 jī: | _____ | 9. 龙 lóng: | _____ |
| 4. 老鼠 lǎo shǔ: | _____ | 10. 猴子 hóu zi: | _____ |
| 5. 马 mǎ: | _____ | 11. 羊 yáng: | _____ |
| 6. 兔子 tù zi: | _____ | 12. 狗 gǒu: | _____ |

Find the above pinyin words in the word search puzzle below.

c	j	l	m	z	k	l	i	g	t	c	i	a
g	n	i	e	o	a	a	a	x	b	k	w	z
c	l	u	t	d	i	d	m	o	l	y	h	c
n	i	l	e	i	a	m	e	d	h	u	o	e
n	t	e	k	a	g	e	m	l	n	u	u	g
h	a	x	h	c	y	c	d	y	a	n	z	b
g	p	k	e	p	g	t	y	l	g	d	i	h
x	y	a	n	g	y	u	g	o	u	j	t	m
p	w	d	s	y	h	j	m	n	s	a	c	a
k	b	x	i	s	i	b	e	g	u	b	u	e
c	s	d	o	a	y	e	k	m	l	y	d	h
l	v	a	e	x	h	y	c	m	t	i	h	b
i	l	y	d	h	c	o	g	o	z	h	a	g
h	s	g	m	u	s	t	x	u	j	o	l	c
k	d	y	h	u	m	k	t	o	h	d	j	e

Word Search: Zodiac Animals ②

找一找：生肖 ●

How many times can you find these animal names in the word search?
Fill in the blanks.

1. 牛： _____ 个。
2. 山羊： _____ 个。
3. 马： _____ 个。
4. 龙： _____ 个。
5. 老虎： _____ 个。
6. 兔子： _____ 个。



Art Project: Chinese Zodiac Lantern
创意手工：生肖灯笼

Instructions:

1. Draw the animals that are missing.
2. Color each animal and cut out the lantern shape.

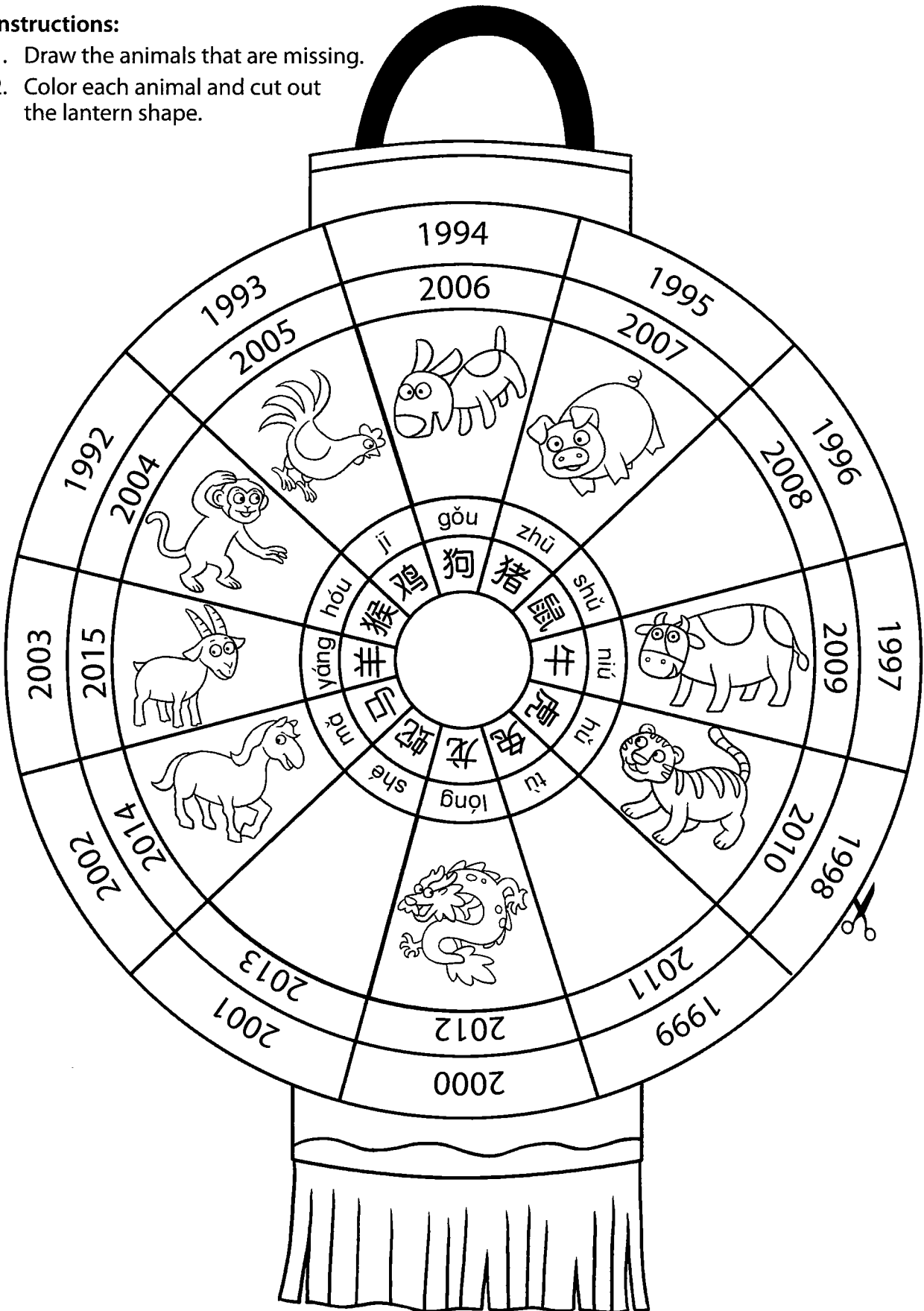

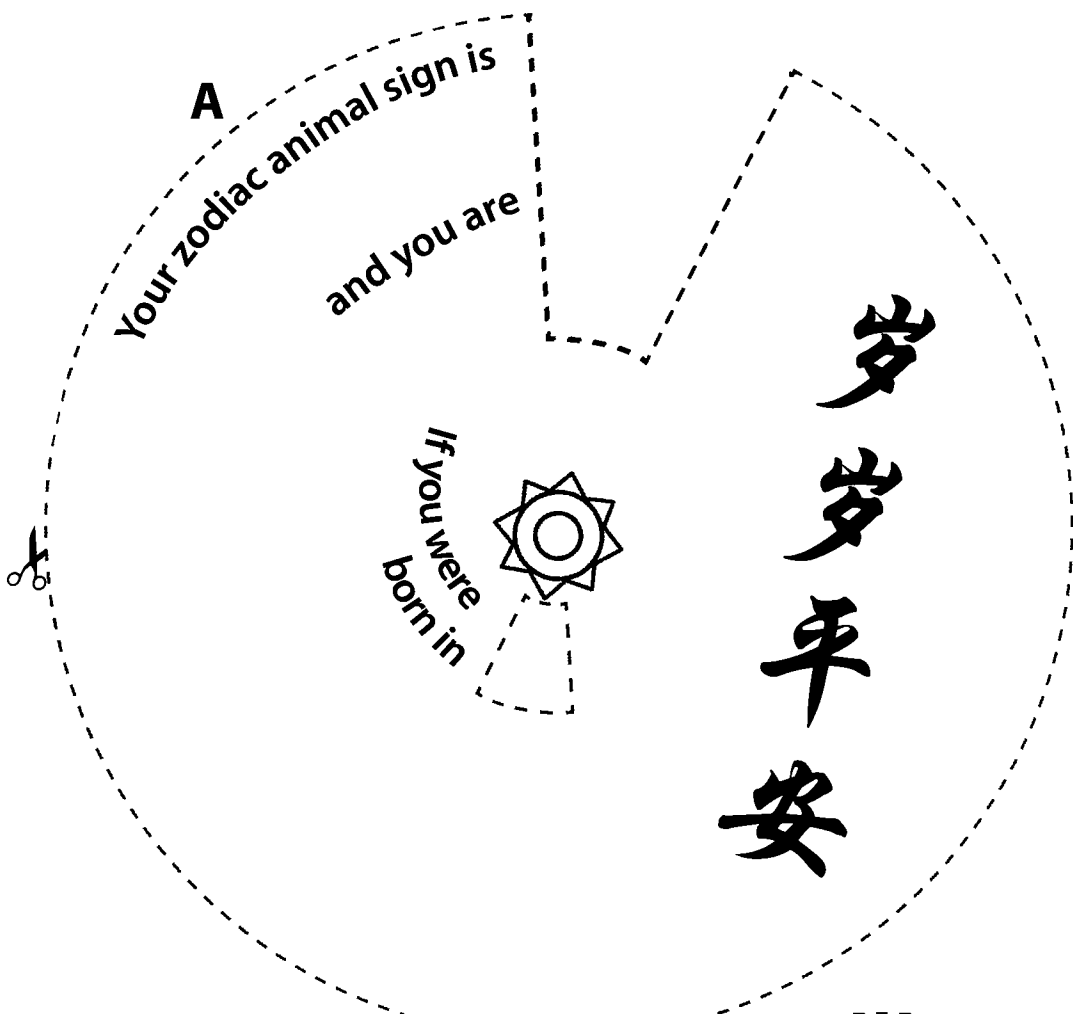

Instructions:

1. Cut out the two wheels. Cut along the dotted lines.
2. Place wheel A over wheel B. Attach the two wheels at the center with a paper fastener.
3. Turn the wheel to find out what your zodiac animal sign is.

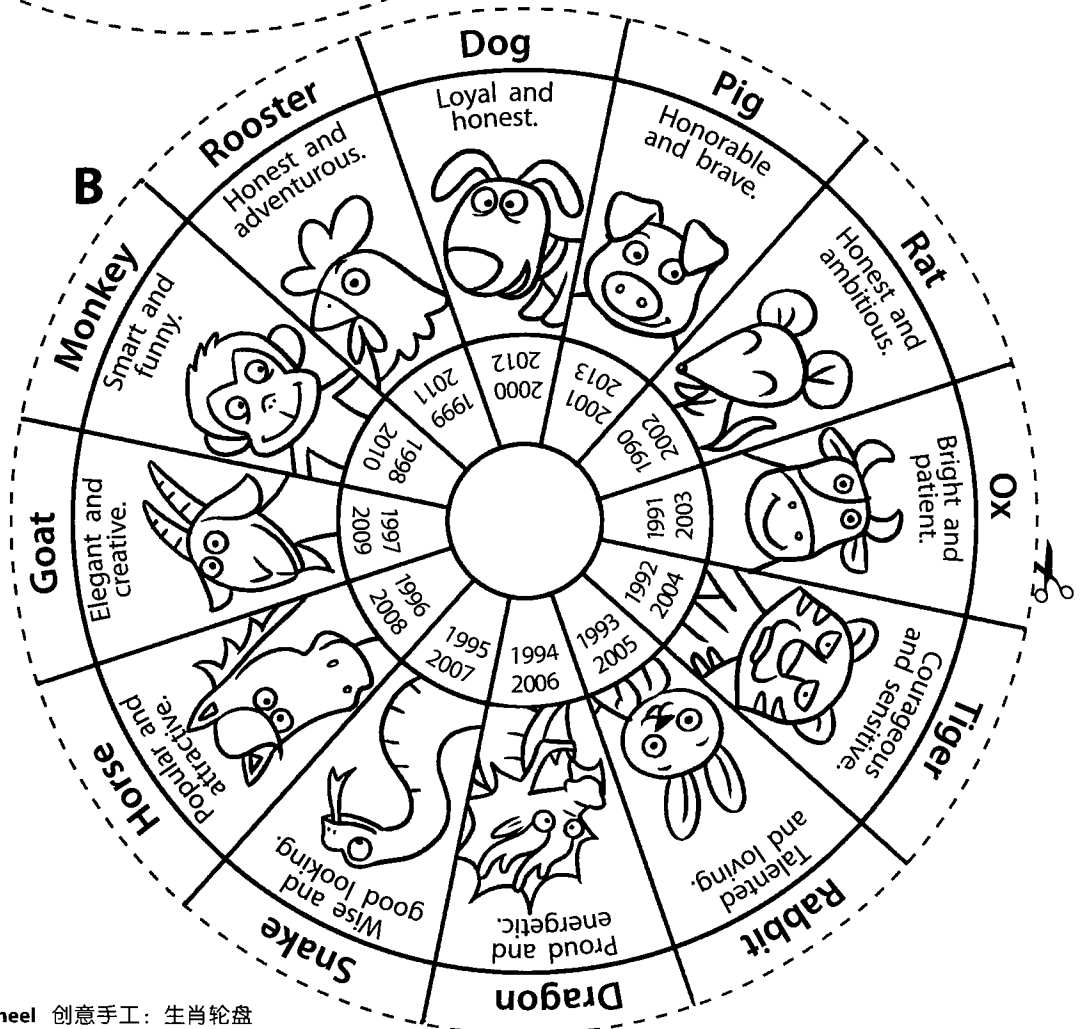

名字：_____ 月_____ 日

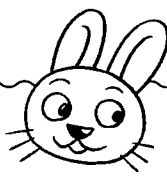
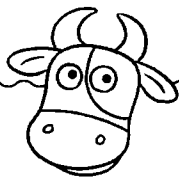

hěn jiǔ yǐ qián zhōng guó yǒu yí gè hěn cōng míng de huáng dì tā guǎn lǐ quán tiān xià
很久以前，中国有一个很聪明的皇帝。他管理全天下
suǒ yǒu de shì qing kě shì huáng dì jiàn jiàn lǎo le cháng cháng wàng jì shì qing yě
所有的事情。可是，皇帝渐渐老了，常常忘记事情，也
wàng jì shí jiān tā xiǎng le hěn jiǔ zhōng yú xiǎng chū le yí gè hǎo bàn fǎ huáng dì
忘记时间。他想了很久，终于想出了一个好办法。皇帝
hěn xǐ huan dòng wù tā xiǎng yòng shí èr zhǒng dòng wù lái jì suàn shí jiān dàn shì yào rú hé
很喜欢动物，他想用十二种动物来计算时间。但是要如何
tiāo xuǎn zhè shí èr zhǒng dòng wù ne wèi le gōng píng qǐ jiàn tā jué dìng jǔ bàn yì chǎng
挑选这十二种动物呢？为了公平起见，他决定举办一场
sài pǎo
赛跑。

dì èr tiān huáng dì zhào jí suǒ yǒu de dòng wù tā shuō dà jiā hǎo jīn tiān
第二天，皇帝召集所有的动物。他说：“大家好！今天
wǒ men yào jǔ bàn yì chǎng dòng wù sài pǎo zuì xiān yóu guò tiān hé pǎo dào zhōng diǎn de
我们要举办一场动物赛跑，最先游过天河、跑到终点的
shí èr zhī dòng wù kě yǐ dài biǎo wǒ men zhōng guó lái jì suàn shí jiān yī dào dá de
十二只动物，可以代表我们中国来计算时间。依到达的
shùn xù měi yì zhī dòng wù dài biǎo yì nián měi shí èr nián chóng fù yí biàn ”
顺序，每一只动物代表一年。每十二年重复一遍。”

sài pǎo kāi shǐ le suǒ yǒu de dòng wù dōu pīn mìng de pǎo dào le tiān hé
赛跑开始了。所有的动物都拼命地跑。到了天河
biān lǎo shǔ qǐng qiú niú zài tā guò hé niú dā yìng le dāng niú gāng cóng shuǐ zhōng shàng
边，老鼠请求牛载它过河，牛答应了。当牛刚从水中上
àn shí lǎo shǔ yòng lì yì tiào fēi kuài de pǎo dào le zhōng diǎn yīn cǐ lǎo shǔ dé le
岸时，老鼠用力一跳，飞快地跑到了终点，因此老鼠得了
dì yī míng suí hòu shì niú hǔ tù lóng shé mǎ yáng hóu
第一名。随后是牛、虎、兔、龙、蛇、马、羊、猴、
jī gǒu zhū zuì hòu sài pǎo jié shù le
鸡、狗、猪。最后赛跑结束了。

zhè jiù shì shí èr shēng xiào de gù shì
这就是十二生肖的故事。

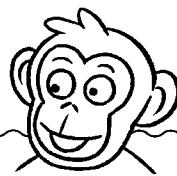
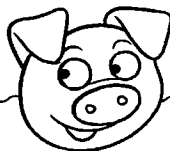

Long, long ago in the ancient Middle Kingdom which we know as China today, there lived a very wise emperor. The emperor was a very important man who had a lot of things on his mind because he had to take care of all the affairs of the people and creatures that lived in the Middle Kingdom. The emperor was getting older and so was becoming more and more forgetful. He was especially worried about how he was getting the years all mixed up in his mind. He couldn't remember the things that happened in each year.

One day while he was thinking about this problem, the emperor decided to name the years after animals because he loved animals. He felt that 12 would be a good number to pick, and, similar to a clock going round in rotation, the animals would also make a cycle. But he did not know which 12 animals to choose. The emperor was known to be a very fair ruler and did not believe he should choose his favorite animals. After some careful thought, he came up with a brilliant idea.

The next morning he called all the animals in the kingdom together and said, "Today we are going to have a great race. The first 12 animals to swim across the River of Heaven and cross the finish line will have the special honor of having a year named after them!"

Well, of course, all the animals were very excited because they all wanted to have a year named after them. The race began and the animals went as fast as they could. When it was time to cross the river, the clever rat, knowing that the strong ox was much stronger, climbed on his back to get a free ride across the river. Just as the ox was climbing out of the river, the rat jumped off, hurried across the finish line and took first place.

After the rat, came the ox, tiger, rabbit, dragon, snake, horse, goat, monkey, rooster, dog, and finally the pig. The race ended. From this day on these 12 animals have had the special honor of having a year named after them.

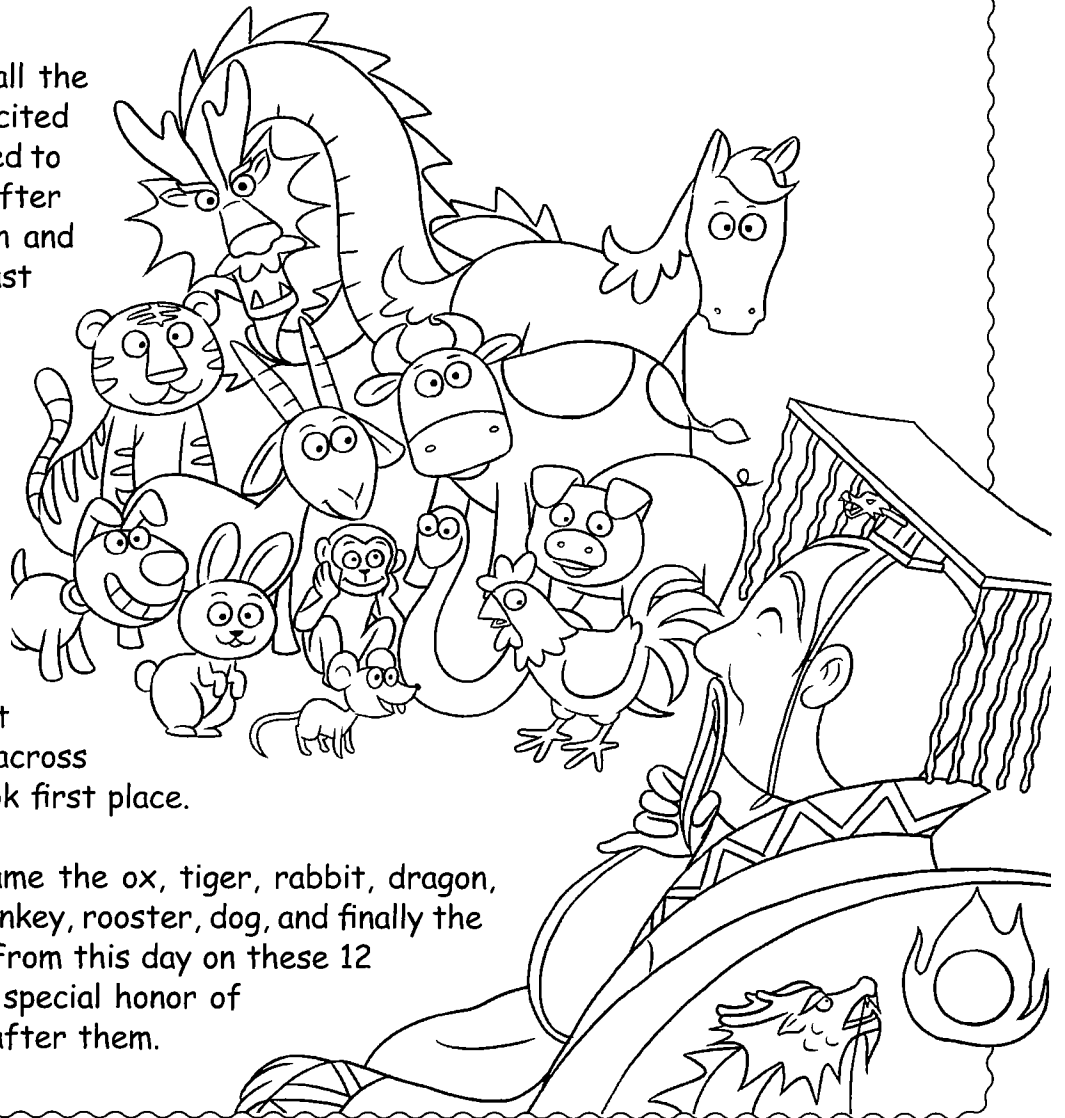

Vocabulary Review: Story of the 12 Zodiac Animals
词汇练习：十二生肖的故事

Match the words in Column A with the words in Column B.

(Column A)

十二生肖
shí èr shēng xiào

请求
qǐng qiú

召集
zhào jí

聪明的
cōng míng de

最先
zuì xiān

结束
jié shù

开始
kāi shǐ

最后
zuì hòu

忘记
wàng jì

动物
dòng wù

赛跑
sài pǎo

重复
chóng fù

(Column B)

wise

ended

asked

animals

first

at last

race

repeated

summoned
(called)

12 zodiac
animals

began

forgot

Quiz: Story of the 12 Zodiac Animals
考考你：十二生肖的故事

动物	最先	最后	开始
结束	十二生肖	重复	请求
赛跑	忘记	聪明的	召集

1. 很久以前，中国有一个很_____皇帝。
2. 可是，皇帝渐渐老了，常常_____事情，也忘记时间。
3. 皇帝很喜欢_____，他想用十二种动物来计算时间。
4. 为了公平起见，他决定举办一场_____。
 _____到达终点的动物可以代表中国计算时间。
5. 第二天，皇帝_____所有的动物。
6. 每一只动物代表一年。每十二年_____一遍。
7. 赛跑_____了。所有的动物都拼命地跑。
8. 到了天河边，老鼠_____牛载它过河。
9. _____赛跑_____了，这就是_____的故事。
10. 依顺序写出十二生肖的名称：

_____、_____、_____、_____

_____、_____、_____、_____

_____、_____、_____、_____

Math Fun: Chinese Zodiac Animals
算一算，数一数：十二生肖

中国新年用十二种动物来代表，称为十二生肖。每一生肖代表一年，以鼠年开始，以猪年结束。然后再重复一次，顺序不变。

On the Chinese calendar, every year is represented by an animal. There are 12 zodiac animals that make a rotation. The cycle begins with the Rat and ends with the Pig. Each animal sign is repeated every 12 years and always follows the same order.

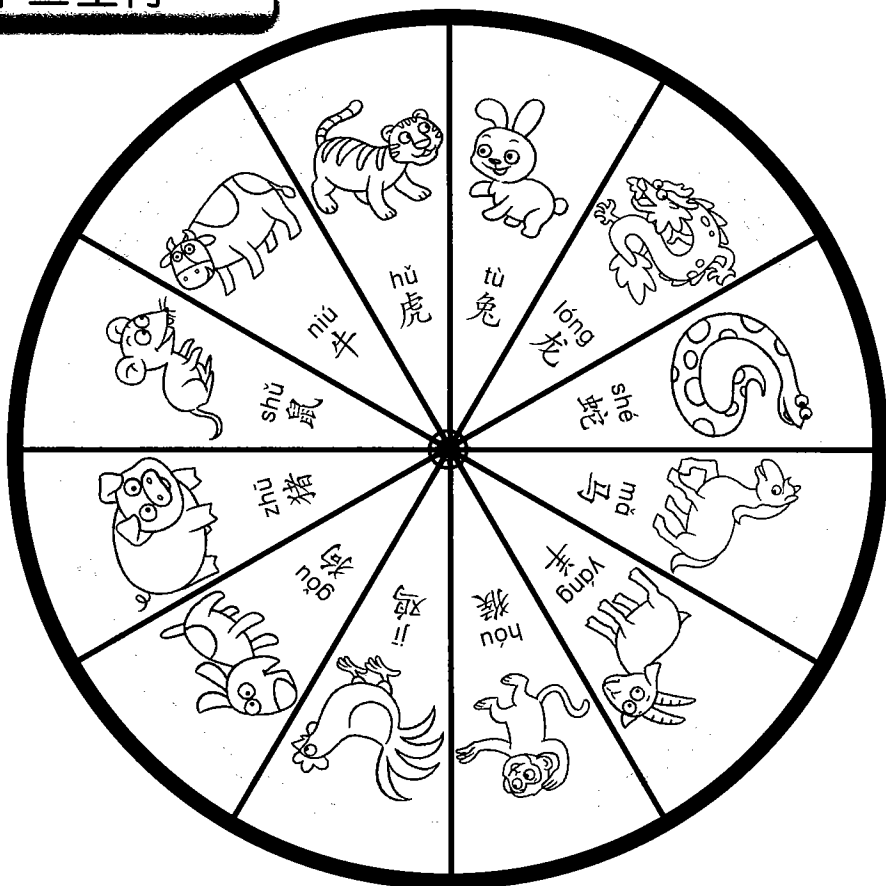

请回答下面问题：

1. 今年是_____年。找出那个生肖，并涂上红色。
 jīn nián shì _____ nián zhǎo chū nà gè shēng xiào bìng tú shàng hóng sè
2. 去年是_____年。找出那个生肖，并涂上黄色。
 qù nián shì _____ nián zhǎo chū nà gè shēng xiào bìng tú shàng huáng sè
3. 明年是_____年。找出那个生肖，并涂上蓝色。
 míng nián shì _____ nián zhǎo chū nà gè shēng xiào bìng tú shàng lán sè
4. 三年前是_____年。找出那个生肖，并涂上绿色。
 sān nián qián shì _____ nián zhǎo chū nà gè shēng xiào bìng tú shàng lǜ sè
5. 十二年后是_____年。
 shí èr nián hòu shì _____ nián

挑战题 (Challenge) :

1. 莉莉今年十岁，属马。他的哥哥属牛。
 莉莉的哥哥比她大_____岁。



shēng xiào

生肖

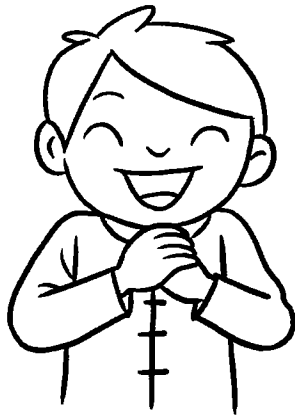

gōng xǐ fā cái

恭喜发财

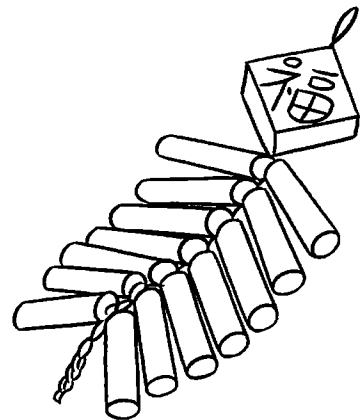

biān pào

鞭炮

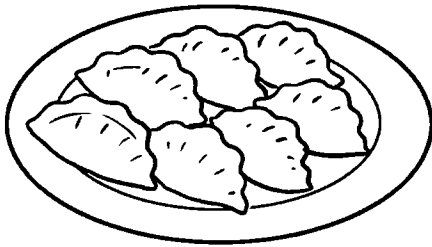

jiǎo zi

饺子



wǔ lóng wǔ shī

舞龙 / 舞狮

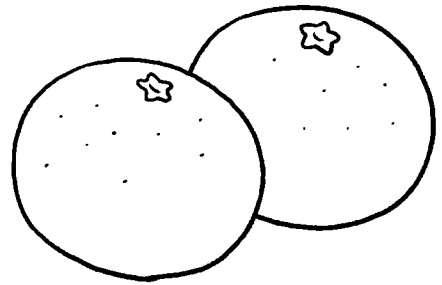

jú zi

桔子

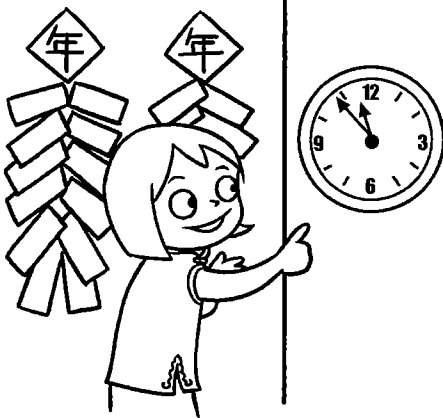

shǒu suì

守岁

stay up late on New Year's Eve

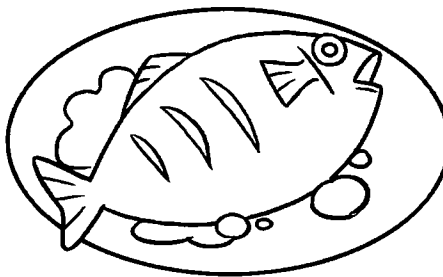

yú

鱼

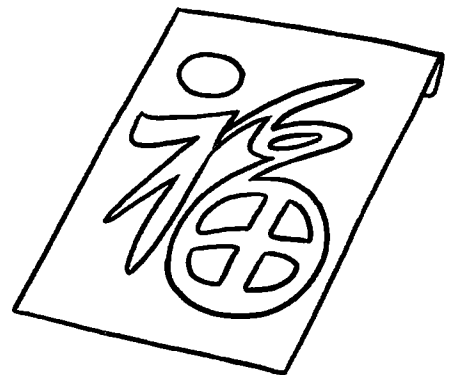

hóng bāo

红包

Word Search: Chinese New Year
找一找: 农历新年

Find the 11 pinyin words from the box below in the Word Search.

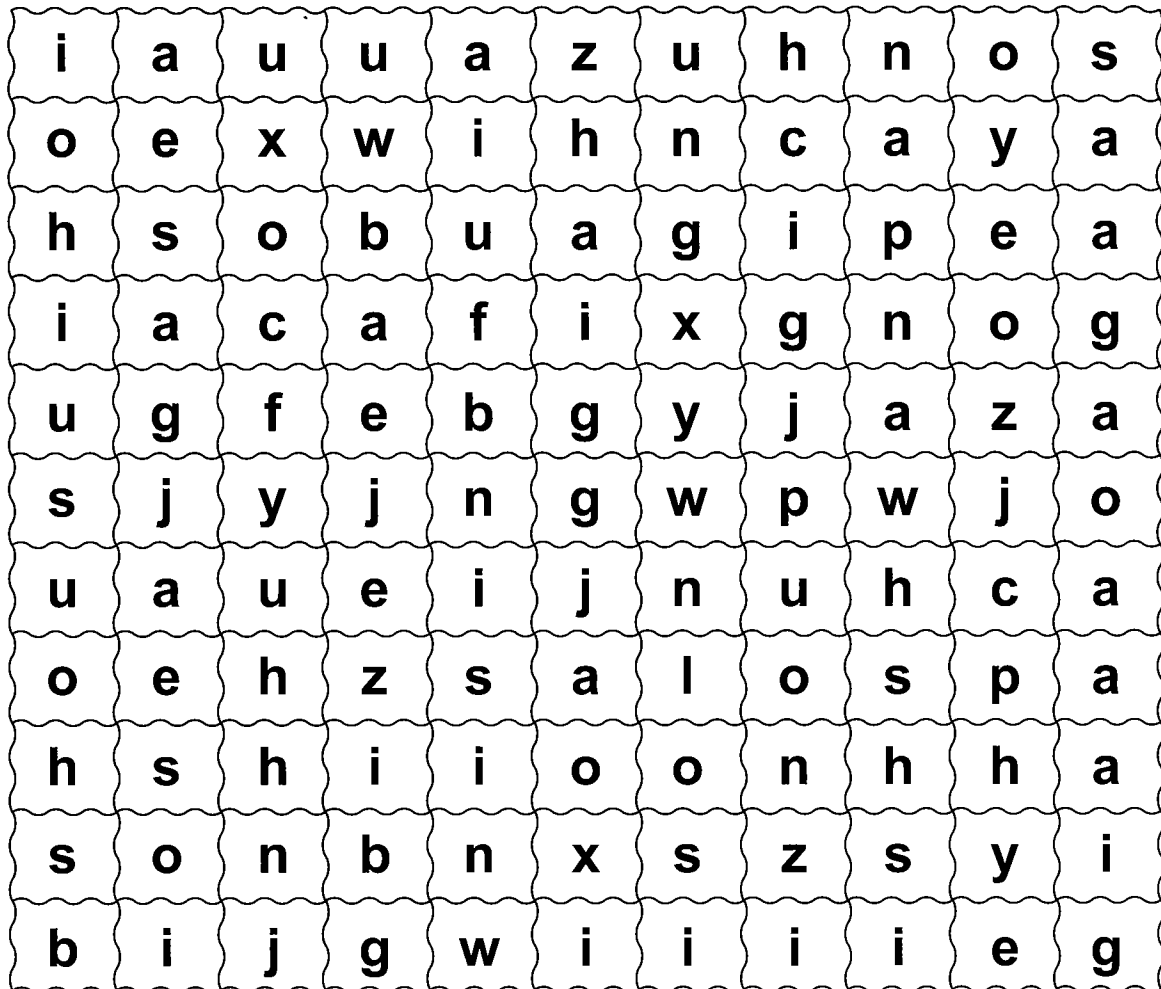

What do these words mean in English?

- | | |
|-------------------------|--------------------------------|
| 1. 春节 chūn jié: _____ | 7. 饺子 jiǎo zi: _____ |
| 2. 红包 hóng bāo: _____ | 8. 舞狮 wǔ shī: _____ |
| 3. 桔子 jú zi: _____ | 9. 守岁 shǒu suì: _____ |
| 4. 生肖 shēng xiào: _____ | 10. 舞龙 wǔ lóng: _____ |
| 5. 鞭炮 biān pào: _____ | 11. 恭喜发财 gōng xǐ fā cái: _____ |
| 6. 鱼 yú: _____ | |

Note: "春节" and "农历新年" both mean "Chinese New Year".

Vocabulary Review: Chinese New Year
词汇练习：农历新年

Fill in the blanks in pinyin or characters using the words below:

gōng xǐ fā cái 恭喜发财	shǒu suì 守岁	hóng bāo 红包	chūn jié 春节	jiǎo zi 饺子
wǔ lóng wǔ shī 舞龙 / 舞狮	yú 鱼	shēng xiào 生肖	biān pào 鞭炮	jú zi 桔子

- The animal signs related to people's age and personality.
- A food served as the last dish on Chinese New Year's Eve and represents "surplus".
- A food served on Chinese New Year's Eve and represents "gold treasure".
- A special lucky envelope that children receive from adults on Chinese New Year.
- A special performance that brings good luck and is associated with drums and firecrackers.
- A fruit that sounds like "good luck".
- A kind of small explosive that creates noise and smoke that will scare the evil spirits away.
- The custom of staying up late on Chinese New Year's Eve.
- A common greeting that people say throughout the period of Chinese New Year.
- Another name for Chinese New Year.

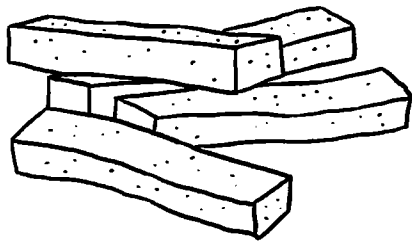

dōng guā táng
冬瓜糖
winter melon candy

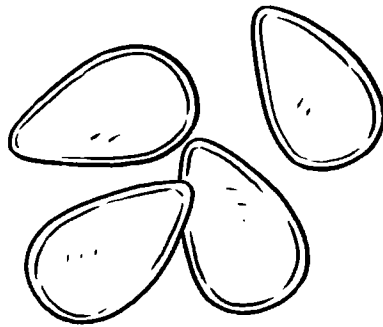

guā zi
瓜子
melon seeds

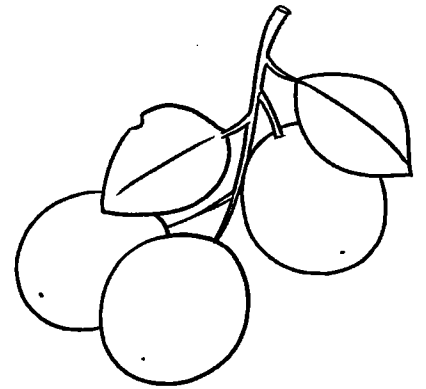

jīn jú
金桔
kumquats

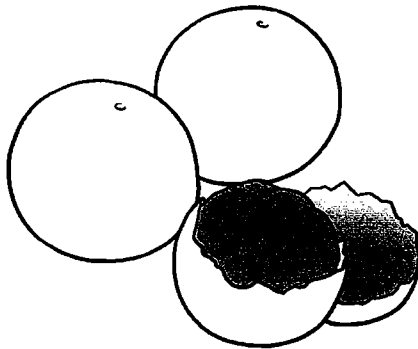

guì yuán
桂圆
longan

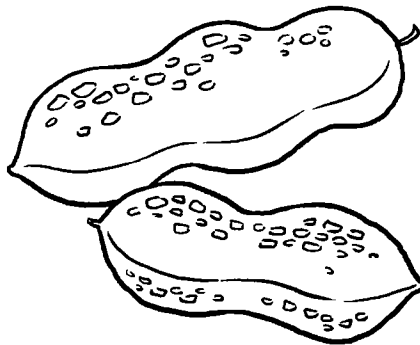

huā shēng
花生

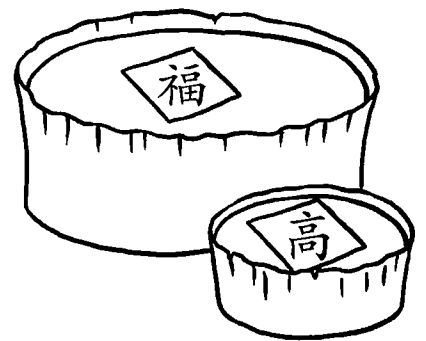

nián gāo
年糕
rice cake



fā gāo
发糕
steamed sponge cake

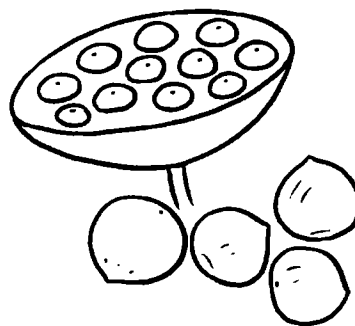

lián zi
莲子
lotus seeds

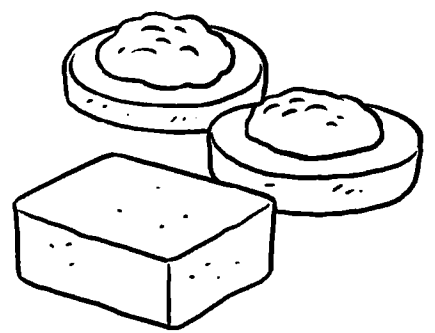

fèng lí sū
凤梨酥
pineapple tarts

Note: Festive snacks for Chinese New Year may vary in different parts of China.

Survey: What Food Do You Like to Eat during Chinese New Year?
问卷: 你喜欢吃什么新年食品?

Instructions:

- Using the dialogue below, conduct a survey in your class to find out which foods your classmates like to eat and which foods they do not like.
- Check under the "喜欢" (Like) column if your classmates like to eat each of the foods; check under "不喜欢" (Dislike) column if they do not.

nǐ xǐ huan chī guā zi ma
 (A) 你喜 欢吃 瓜子 吗?

wǒ xǐ huan / bù xǐ huan chī guā zi
 (B) 我喜 欢 / 不喜 欢吃 瓜子。

nǐ xǐ huan chī _____ ma
 (A) 你喜 欢吃 _____ 吗?

wǒ xǐ huan / bù xǐ huan chī _____
 (B) 我喜 欢 / 不喜 欢吃 _____。

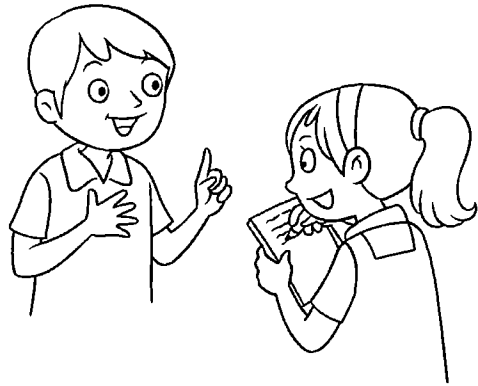

	喜 欢	不 喜 欢	喜 欢	不 喜 欢	喜 欢	不 喜 欢	喜 欢	不 喜 欢	喜 欢	不 喜 欢	喜 欢	不 喜 欢	喜 欢	不 喜 欢	喜 欢	不 喜 欢
十人																
九人																
八人																
七人																
六人																
五人																
四人																
三人																
二人																
一人																

Number of students asked in the survey

Popular food for Chinese New Year

Rhyme: Chinese New Year Is Coming!
数来宝：新年到！

咚咚锵，咚咚锵，
咚咚咚锵咚咚咚锵。

Dōng dōng qiāng, dōng dōng qiāng,
dōng dōng dōng qiāng dōng dōng dōng qiāng.

(Sound imitation of the gongs and drums)

新年好，新年好。
穿新衣，戴新帽。
恭喜新年，春来到！

Xīn nián hǎo, xīn nián hǎo.
Chuān xīn yī, dài xīn mào.
Gōng xǐ xīn nián, chūn lái dào!

Happy New Year! Happy New Year!
Wear new clothes. Wear new hats.
Welcome the New Year. Welcome Spring!



咚咚锵，咚咚锵，
咚咚咚锵咚咚咚锵。

Dōng dōng qiāng, dōng dōng qiāng,
dōng dōng dōng qiāng dōng dōng dōng qiāng.

(Sound imitation of the gongs and drums)

新年好，新年好。
拿红包，放鞭炮。
舞龙舞狮，真热闹！
真 - 热 - 闹！

Xīn nián hǎo, xīn nián hǎo.
Ná hóng bāo, fàng biān pào.
Wǔ lóng wǔ shī, zhēn rè nào!
Zhēn - rè - nào!

Happy New Year! Happy New Year!
Get the red envelopes. Set off the firecrackers.
Dragon dances, lion dances, so amazing!
A - M - A - Z - I - N - G!

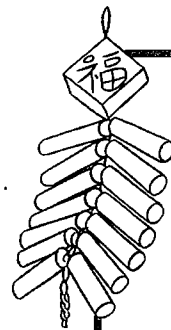

读一读：

Can you read the following words?

新年

衣

帽

红包

鞭炮

舞龙舞狮

真热闹

guò xīn nián

过新年

Chinese New Year Celebration



名字: _____

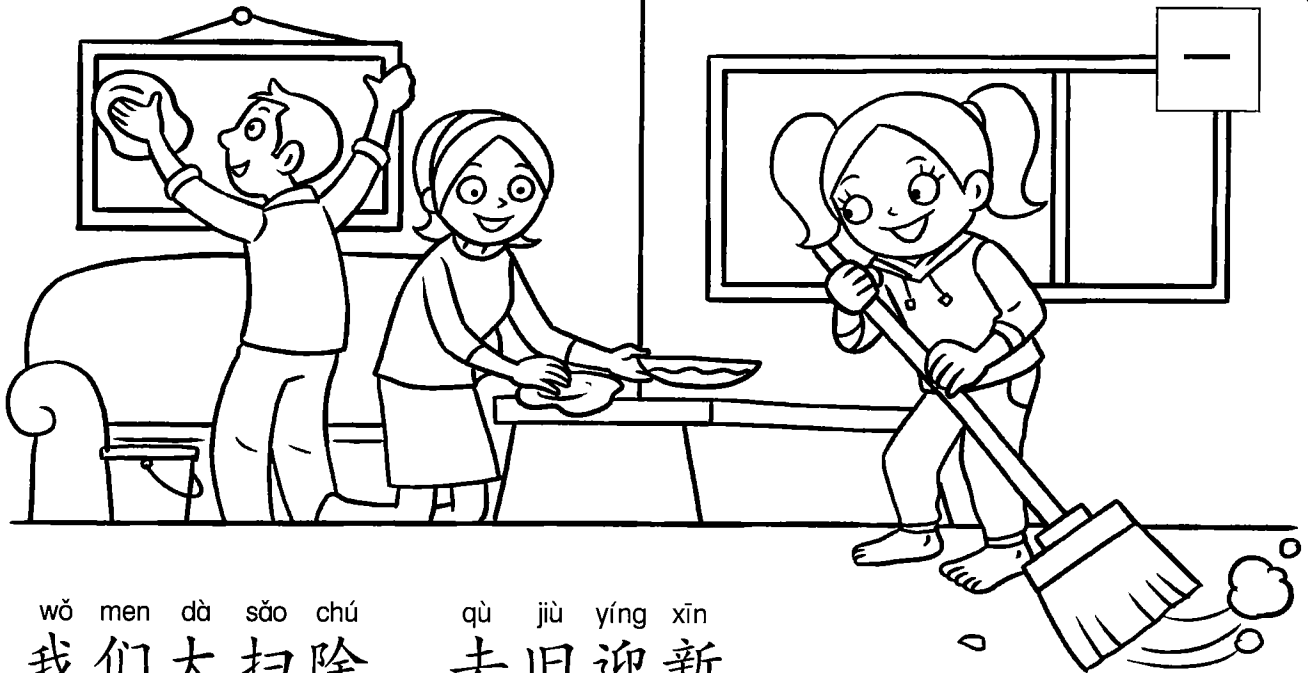

wǒ men dà sǎo chú qù jiù yíng xīn
我们大扫除，去旧迎新。

We c_____ the house and s_____ the floor.

It is time to get rid of the old and welcome the _____ year.

二



wǒ men tiē chūn lián jiǎn chūn huā dà jí dà lì
 我们贴春联，剪春花，大吉大利。

We put up red c_____ and p_____ c_____ on doors and windows for good luck.



三

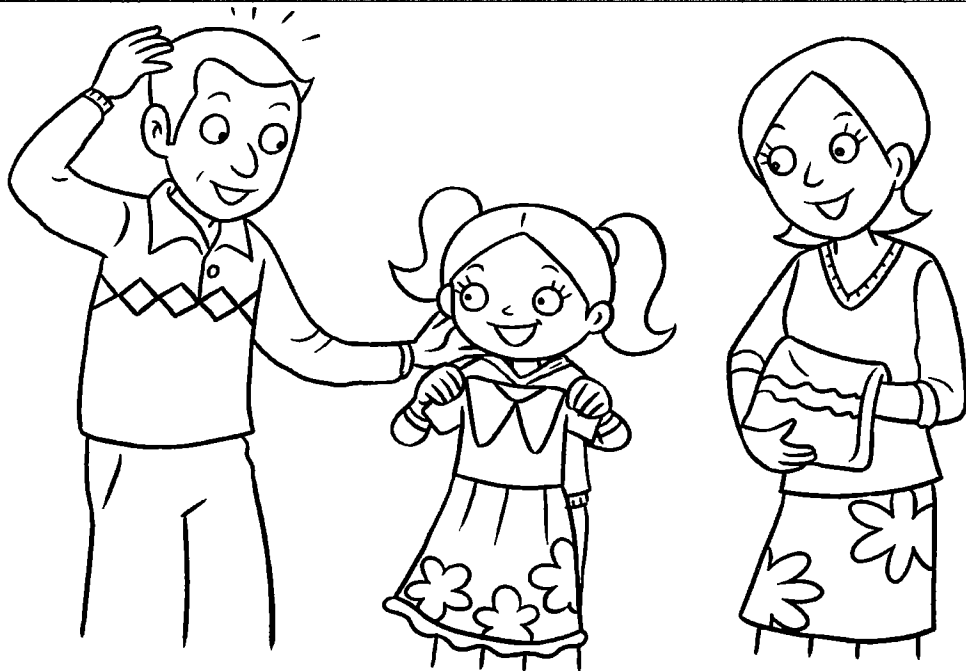

wǒ men mǎi xīn yī fu jiǎn tóu fa xīn nián kuài lè
 我们买新衣服，剪头发，新年快乐。

We buy new c_____ and get h_____ to start the new year.

On Chinese New Year's Eve

四



wǒ men huí jiā chī nián yè fàn tuán tuán yuán yuán
我们回家吃年夜饭，团团圆圆。

We go home for a big family r_____ dinner on New Year's Eve.

五

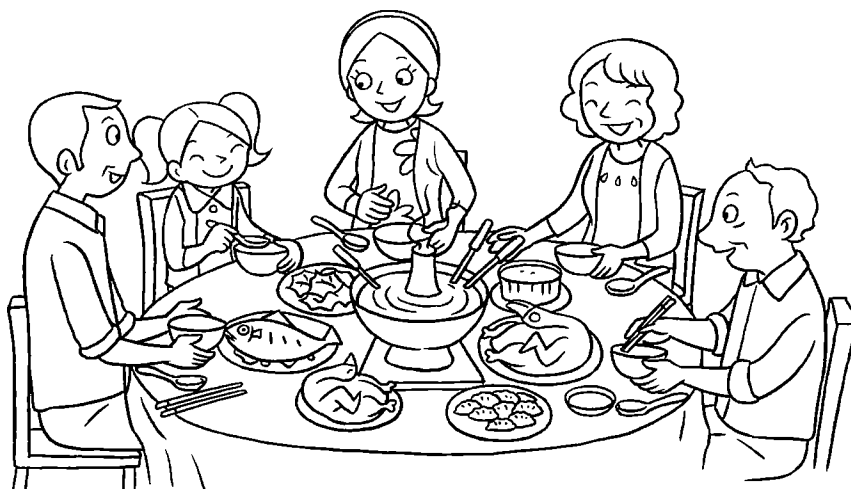

wǒ men chī jī yā yú jiǎo zi nián gāo hé huǒ guō
我们吃鸡、鸭、鱼、饺子、年糕和火锅，
吉祥如意。

We eat c_____, d_____, f_____, d_____,
rice cakes and hotpots. All are symbolic of good luck and good wealth.

On Chinese New Year

六



wǒ men xiàng dà ren bài nián suì suì píng ān
我们向大人拜年，岁岁平安。

We say "G_____ " to grown-ups and receive red _____
for good luck.

七

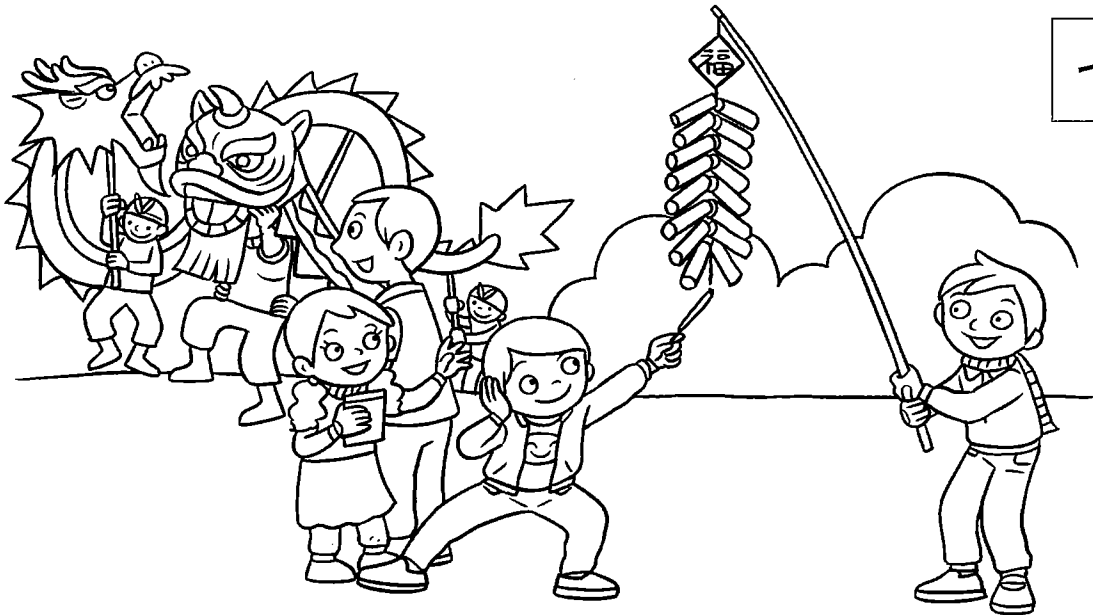

wǒ men fàng biān pào kàn wǔ lóng wǔ shī qìng zhù xīn nián
我们放鞭炮，看舞龙舞狮，庆祝新年。

We set off the _____ and watch the lion dance and dragon
parade to celebrate the New Year.

Character Code Challenge: Chinese New Year Message ①
解码游戏: 新年密语 ①

Use the character codes below to solve the secret message about Chinese New Year.

A: 一	B: 二	C: 三	D: 四	E: 五	F: 六
G: 七	H: 八	I: 九	J: 十	K: 口	L: 手
M: 人	N: 天	O: 木	P: 心	Q: 日	R: 月
S: 山	T: 水	U: 火	V: 上	W: 下	X: 大
Y: 小	Z: 中				

下五 下五一月 月五四 六木月
 七木木四 手火三口 一天四 水木
 山三一月五 一下一小 五上九手
 山心九月九水山

yī 一 one	èr 二 two	sān 三 three	sì 四 four	wǔ 五 five	liù 六 six	qī 七 seven
bā 八 eight	jiǔ 九 nine	shí 十 ten	kǒu 口 mouth	shǒu 手 hand	rén 人 person	tiān 天 sky
mù 木 wood	xīn 心 heart	rì 日 sun	yuè 月 moon	shān 山 mountain	shuǐ 水 water	huǒ 火 fire
shàng 上 up	xià 下 down	dà 大 big	xiǎo 小 small	zhōng 中 middle		

Character Code Challenge: Chinese New Year Message ②
解码游戏：新年密语 ②

Use the character codes below to solve the secret message about Chinese New Year.

A: 木	B: 月	C: 下	D: 田	E: 手	F: 一
G: 火	H: 人	I: 小	J: 男	K: 口	L: 二
M: 水	N: 大	O: 牛	P: 耳	Q: 子	R: 三
S: 山	T: 上	U: 女	V: 目	W: 心	X: 四
Y: 日	Z: 中				

心 人 牛 二 手 一 小 山 人 木 三 手 山 手 三 目 手 田

心 小 上 人 上 人 手 人 手 木 田 山 木 大 田 上 木 小 二 山

牛 大 上 牛 山 日 水 月 牛 二 小 中 手 人 木 耳 耳 日

月 手 火 小 大 大 小 大 火 山 木 大 田

手 大 田 小 大 火 山

mù 木 wood	yuè 月 moon	xià 下 down	tián 田 field	shǒu 手 hand	yī 一 one	huǒ 火 fire
rén 人 person	xiǎo 小 small	nán 男 man	kǒu 口 mouth	èr 二 two	shuǐ 水 water	dà 大 big
niú 牛 cow	ěr 耳 ear	zǐ 子 child	sān 三 three	shān 山 mountain	shàng 上 up	nǚ 女 female
mù 目 eye	xīn 心 heart	sì 四 four	rì 日 sun	zhōng 中 middle		

Art Project: Lucky Messages for New Year
创意手工: 新年吉祥话

dà jí dà lì
大吉大利
May you have lots of
good luck and fortune.

jí xiáng rú yì
吉祥如意
May you have good fortune
in all your affairs.

chū rù píng ān
出入平安
May you have peace
wherever you go.

sì jì píng ān
四季平安
May you have peace throughout
the four seasons.

wǔ fú lín mén
五福临门
May the five good fortunes
come through your door.

lǎo shào píng ān
老少平安
May everyone in your family
be safe and sound.

名字： _____

_____ 月 _____ 日

Art Project: Chinese New Year Couplets
创意手工：对联

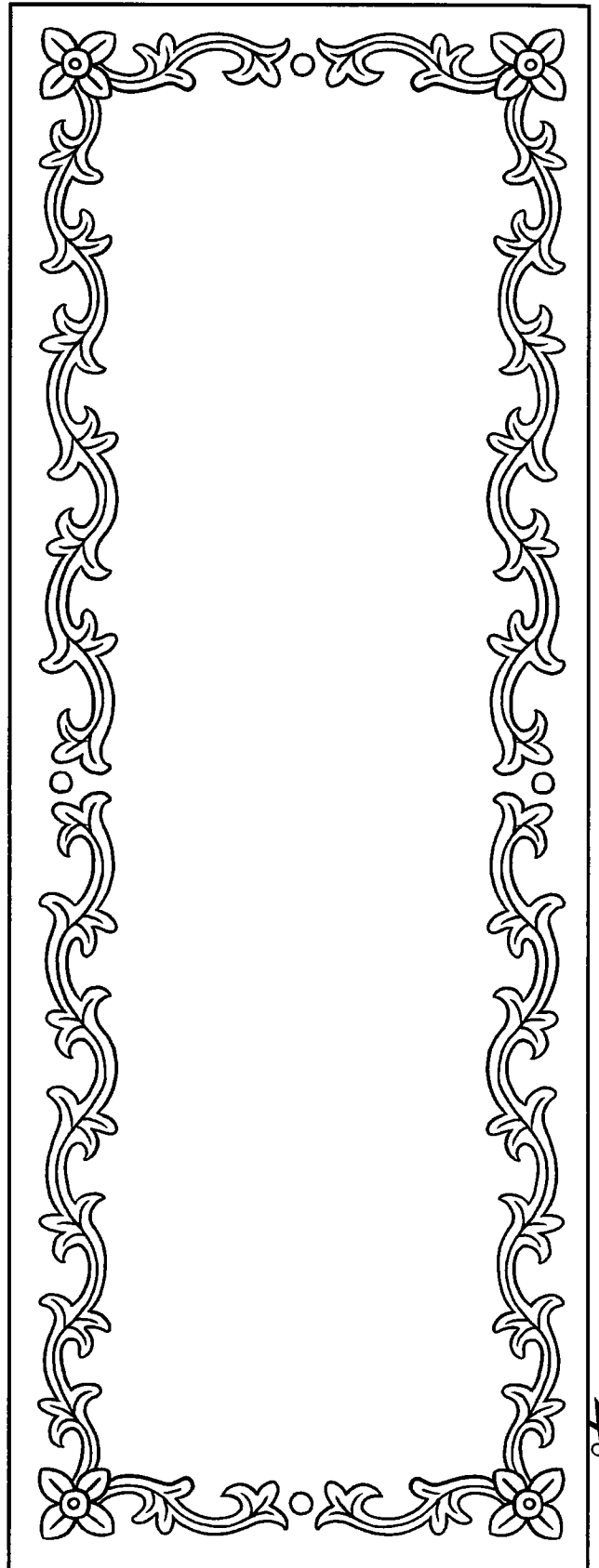
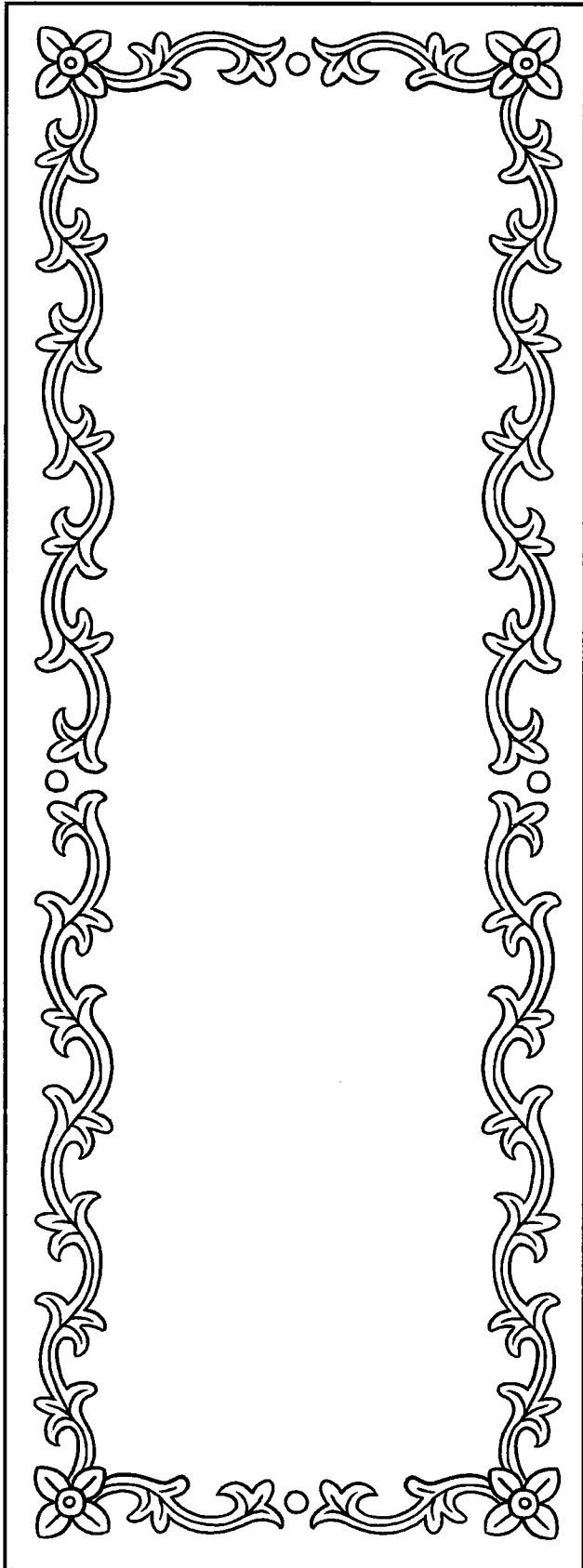

名字： _____ 月 _____ 日

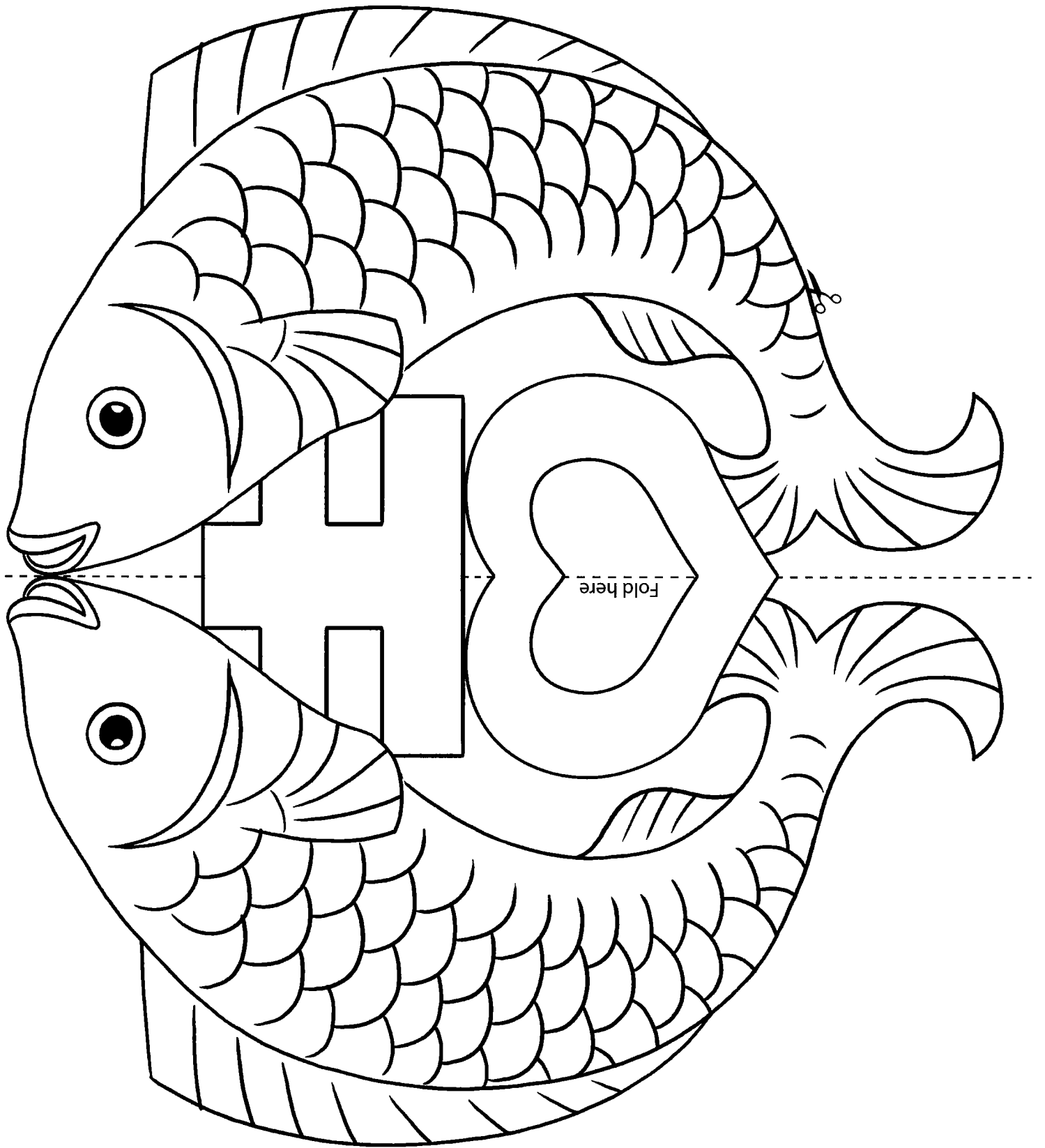

名字： _____ 月 _____ 日

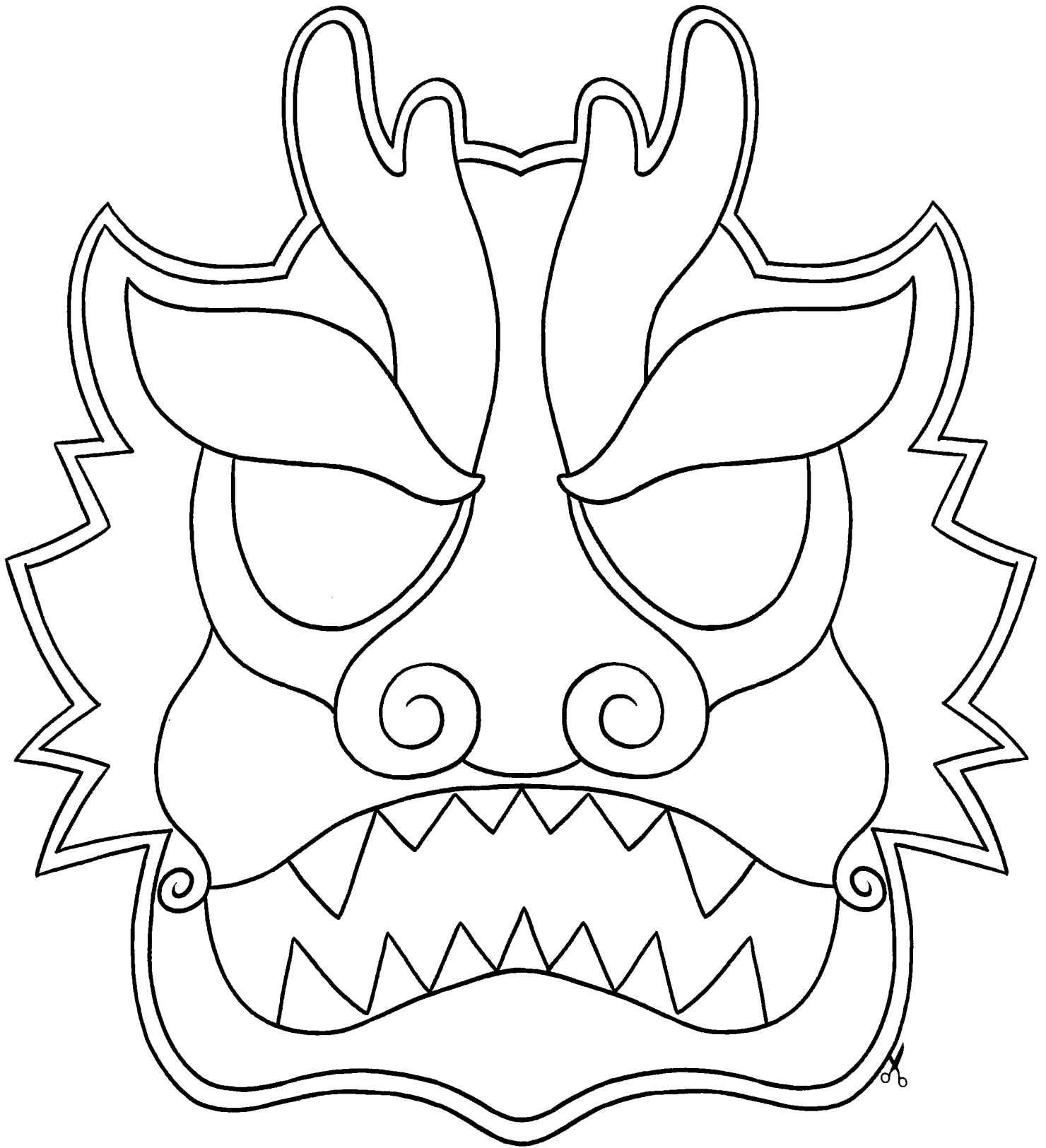

Note: Refer to instructions on p. 9.



Instructions:

1. Trace a template of 9" circle on red construction paper to make the body of the fish.
2. Cut out a triangle from the circle to form a mouth.
3. Staple the small triangle piece to the opposite side to form a tail.
4. Color the picture of the fish above. Cut it out and paste it in the center of the red fish.
5. Add a fish eye above the mouth.
6. Decorate the fish with a pattern or a lucky message.

Note: See sample on p. 400.

名字: _____

_____月_____日

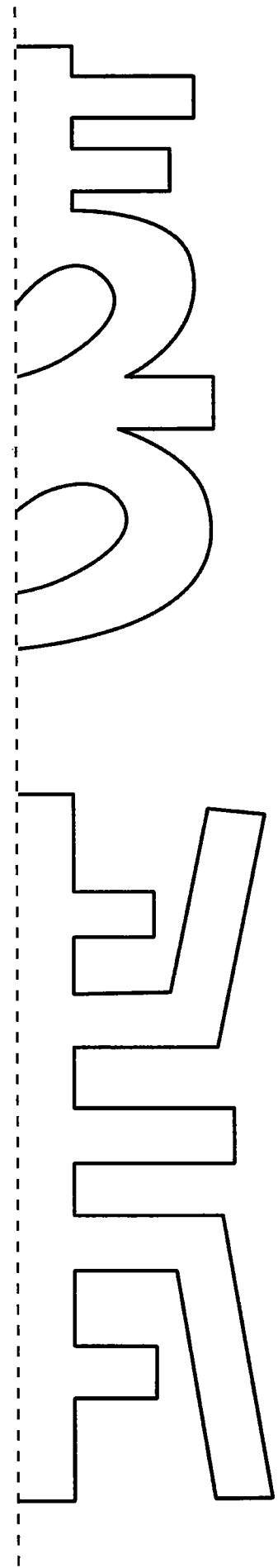
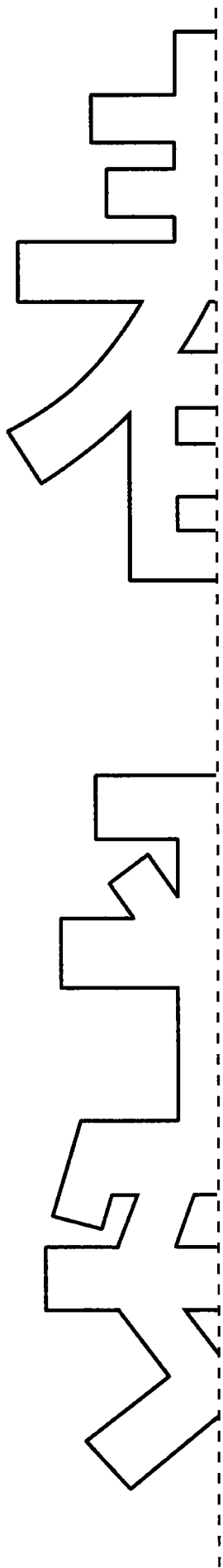

Art Project: Red Envelope
创意手工：红包

A hongbao is a red envelope decorated with gold writing or pictures. It contains lucky money and is a traditional Chinese New Year's gift for children. Below is a template for making your own hongbao.

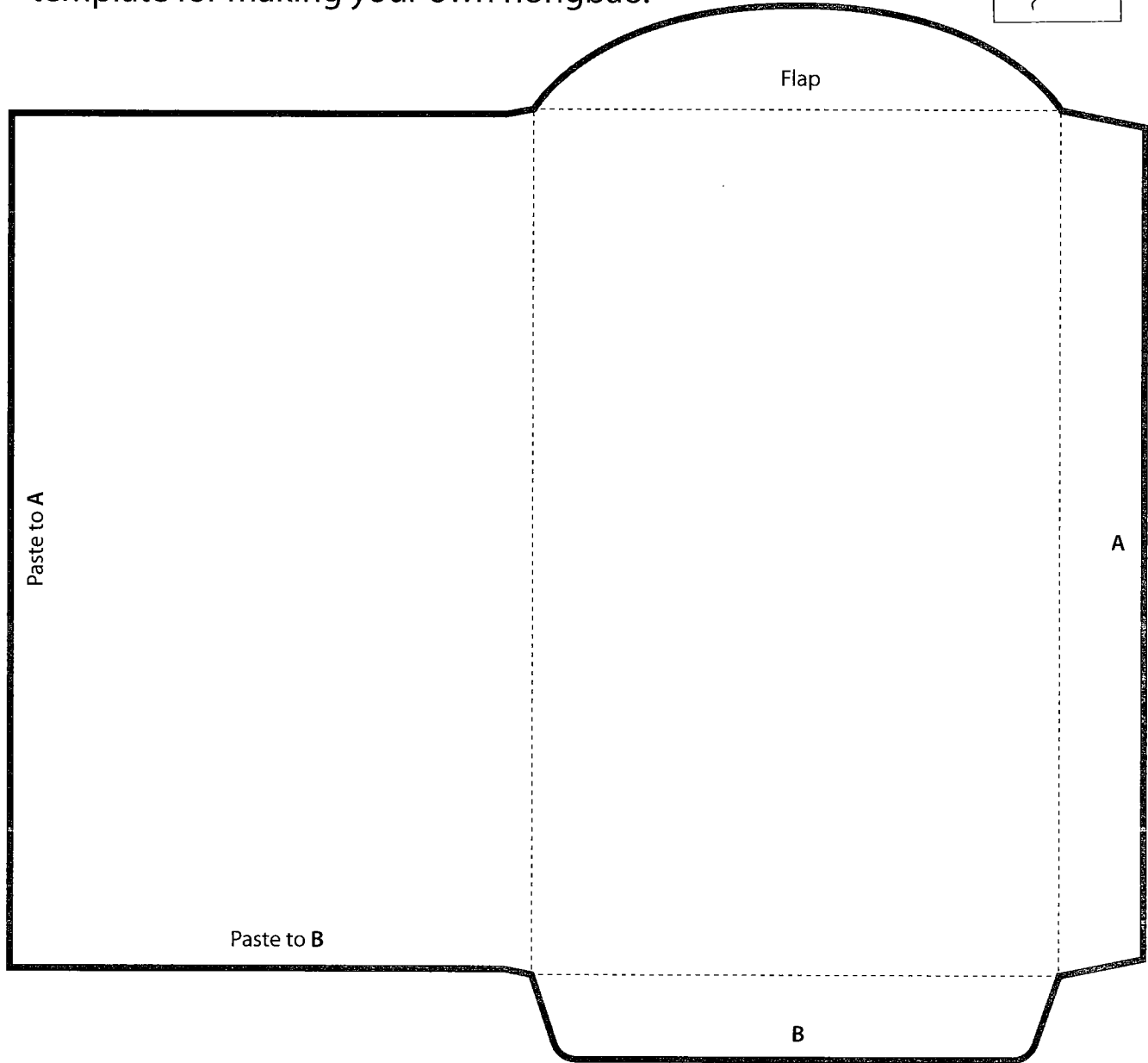
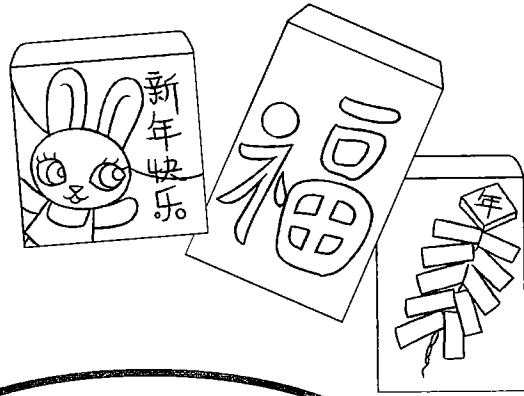

Instructions:

1. Place the template on top of a piece of red paper and cut along the outer edges.
2. Fold along the dotted lines and paste the paper as indicated.
3. Decorate your hongbao using popular Chinese New Year symbols such as lion dance, firecracker, fish, and lucky messages. Or, you can decorate it with your own design.

Art Project: Firecrackers
创意手工：鞭炮

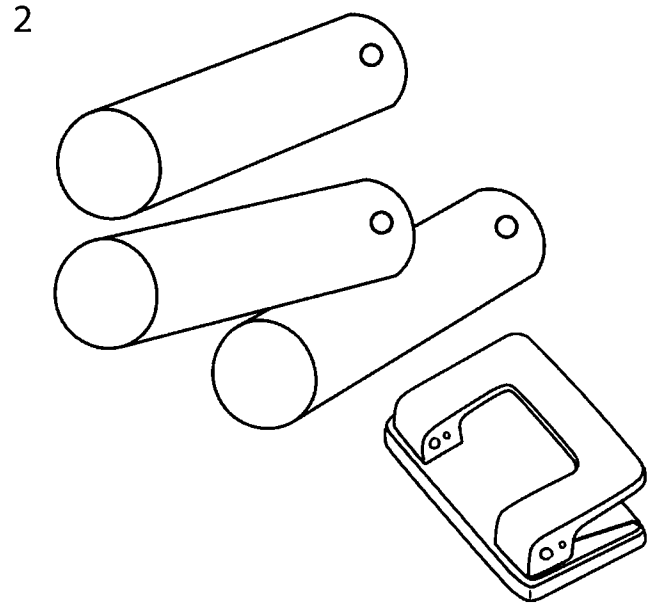
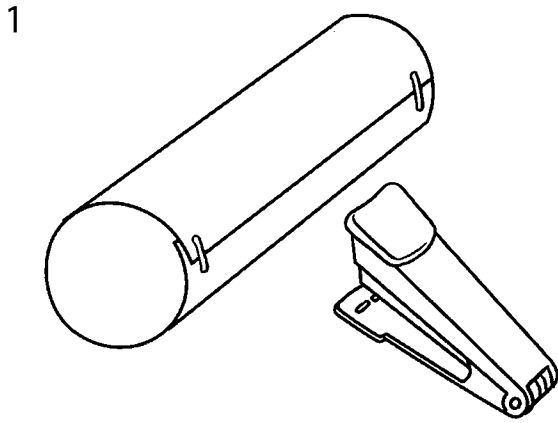

Materials needed:

- Red paper 3" x 4" – 6 pieces
- Red paper 2" x 6" – 1 piece
- Red yarn 1 ½ ft. – 1 piece

Instructions:

1. Roll the small red paper into a tube and staple it.
2. Punch a hole on the top of each tube.
3. Thread the yarn into each hole and make a knot.
4. Write a lucky message on the big red paper and tie it to the tail.

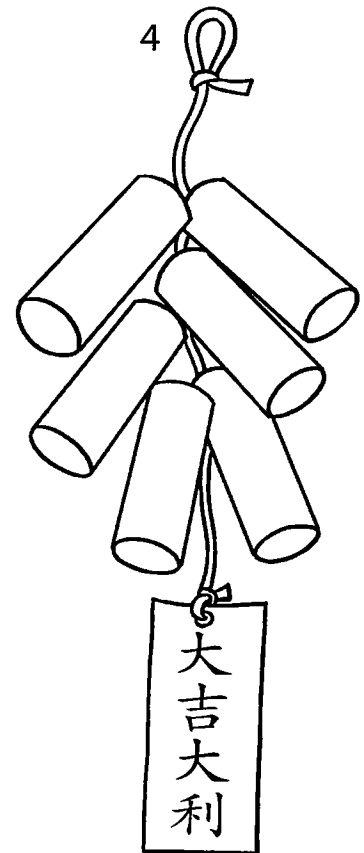
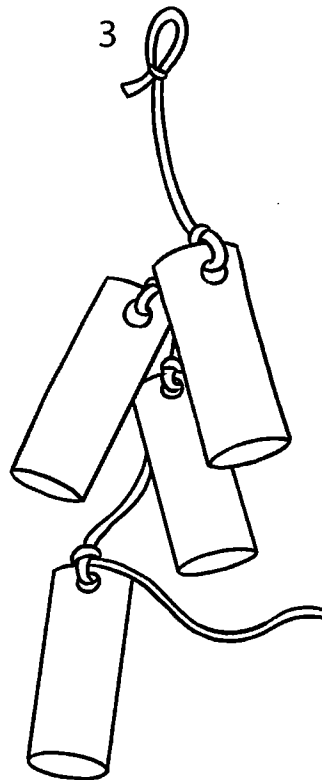

Who can reach the Dragon's Head first?

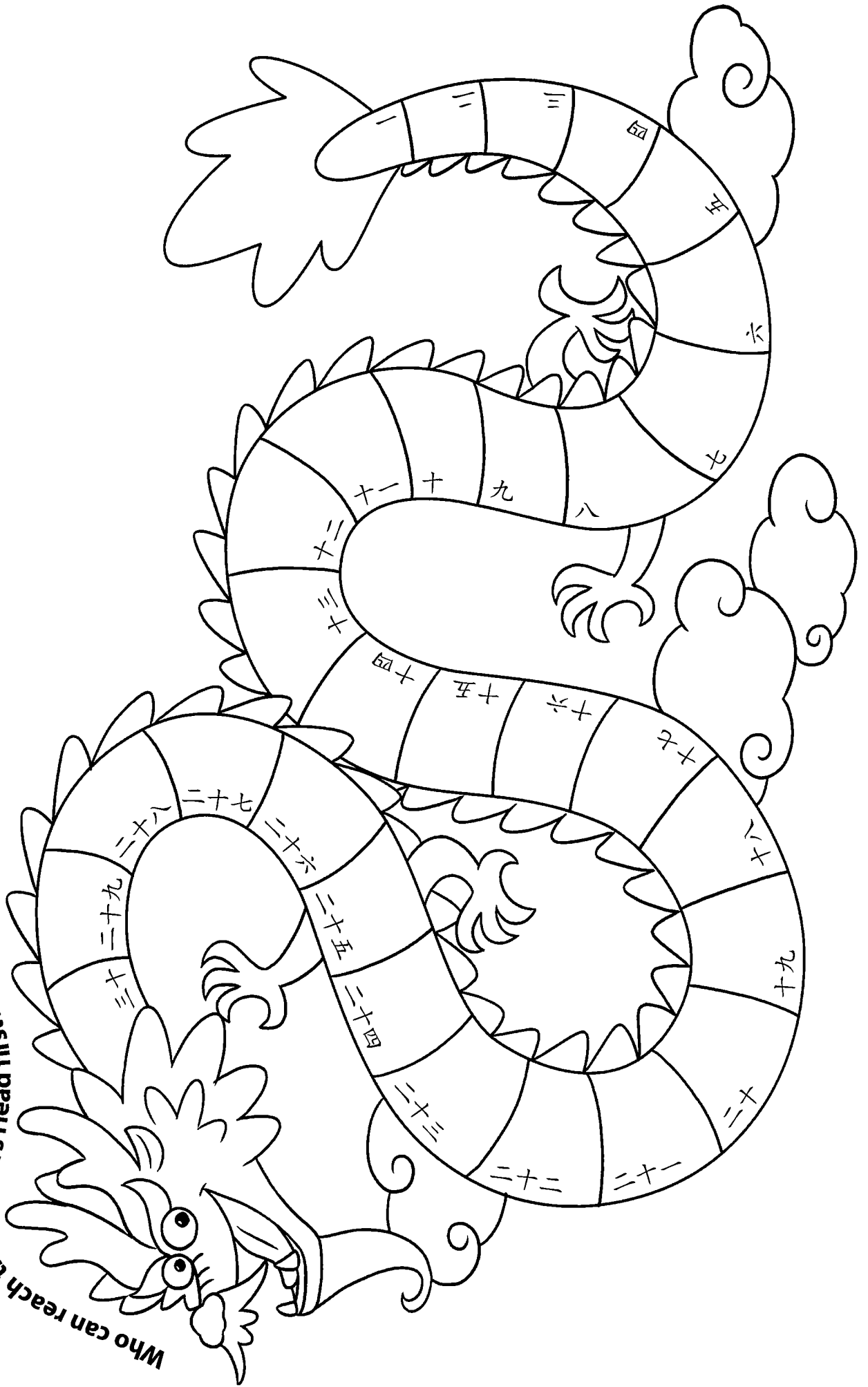

Game: Chinese New Year Qs and As
问答游戏：农历新年知多少

今年是什么
生肖年？

What is the animal
sign for this year?

2 Points

一共有几
个生肖？

How many Zodiac
animals are there?

2 Points

动物赛跑，
谁跑第一名？

Who is the winner in
the Zodiac Race?

1 Point

十二生肖最后
一名是谁？

Who is the 12th winner
in the Zodiac Race?

2 Points

十二生肖里
有没有猫？

Is the cat one of
the Zodiac animals?

2 Points

今年农历新年
是几月几日？

When is Chinese New Year
this year?

3 Points

新年的吉祥
颜色是什么？

What is the good luck color
for Chinese New Year?

1 Point

小孩子过年会收
到什么礼物？

What do children
receive from adults on
Chinese New year?

2 Points

农历新年
又叫什么？

What is the other name
for Chinese New Year?

3 Points

鱼在过年
时代表什么？

What does fish symbolize
in Chinese New Year?

2 Points

为什么过年要穿红
衣服和新衣服？

Why do Chinese people
wear red and new clothes
on Chinese New Year?

1 Point

红包里面
装了些什么？

What is inside the
red envelopes?

1 Point

为什么过年
要放鞭炮？

Why do Chinese people
light firecrackers during
Chinese New Year?

2 Points

元宵节是
什么时候？

When is the
Lantern Festival?

2 Points

请说一句
新年吉祥话。

Say one good luck
greeting in Chinese.

3 Points

Song: Happy New Year!

新年歌： 恭喜！ 恭喜！

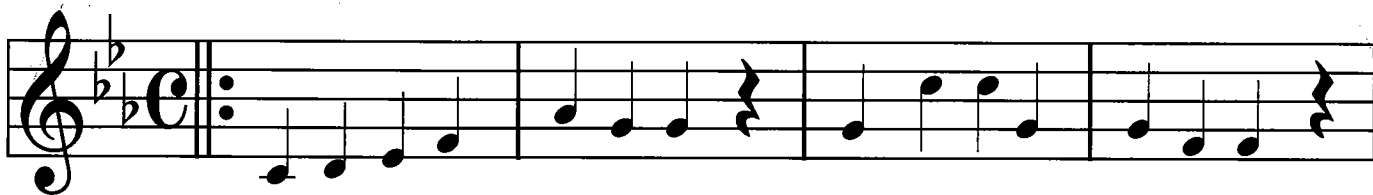

měi tiáo dà jiē xiǎo xiàng měi gè rén de zuǐ li
每条大街小巷， 每个人的嘴里，
From big streets to little lanes, People clamor shine or rain.



jiàn miàn dì yí jù huà jiù shì gōng xǐ gōng xǐ ā!
见面第一句话， 就是恭喜恭喜啊！
Voices ring with merry calls, Happy new year to all! ... Hah!



gōng xǐ gōng xǐ gōng xǐ nǐ ya gōng xǐ gōng xǐ gōng xǐ nǐ
恭喜恭喜 恭喜你呀！ 恭喜恭喜 恭喜你！
Happy, happy greetings to all! Happy New Year to you all!



Recipe: Dumplings
下厨乐：包饺子

Ingredients

- 1 lb. Chinese cabbage
- 2 scallions
- 2 cloves of garlic, finely chopped
- 2 tsp. fresh ginger, finely chopped
- 1 tbsp. soy sauce
- 1 tbsp. sesame oil
- 1 tsp. salt
- 1 tbsp. cornstarch
- 1 lb. lean ground pork
- 1 10-oz. package prepared dumpling wrappers (available at Asian food stores)

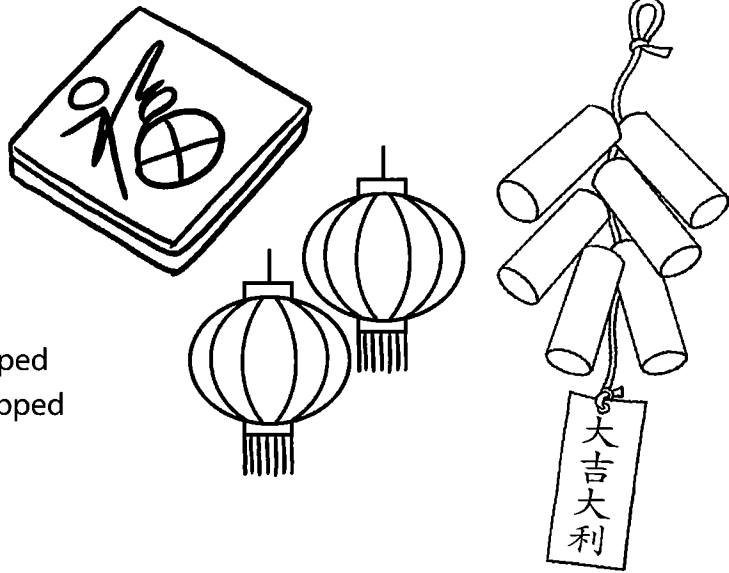

Steps

Part 1:

1. Finely chop the Chinese cabbage and scallions and put them in a mixing bowl.
2. Add the soy sauce, salt, cornstarch, and pork. Mix well with a spoon.
3. Place 1 teaspoon of filling on each wrapper.
4. Fold the wrappers into half circles. Moisten the edges with water, and press them together to seal.

Part 2:

1. In a large pot, bring 2 quarts of water to a boil.
2. Put in the dumplings and cover the pot. When the water starts boiling, add 1 cup of cold water.
3. Repeat this step twice. When the water boils for the third time, the dumplings are done.
4. Serve with 1/4 cup of soy sauce mixed with 2 tablespoons of vinegar. Makes 4 dozen dumplings.

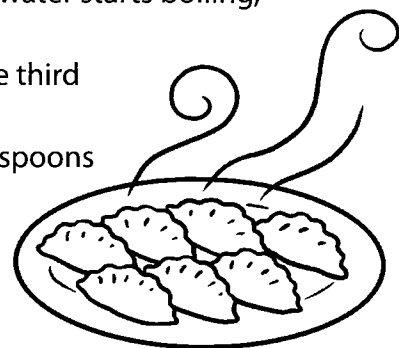

yuán xiāo jié
元宵节
The Lantern Festival

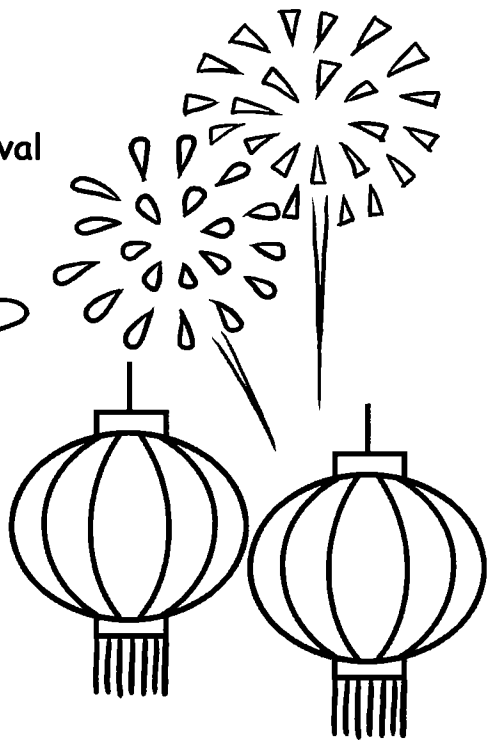
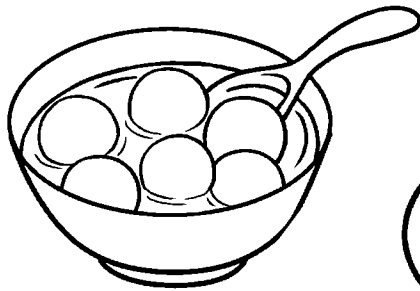

名字: _____



春

一

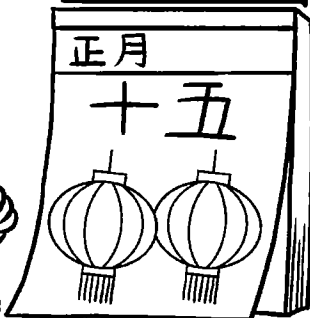

zhēng yuè shí wǔ shì yuán xiāo jié tā shì chūn jié de zuì hòu yì tiān
正月十五是元宵节。它是春节的最后一天。

The _____ day of Chinese New Year is the _____ Festival.
It marks an end to the 15 days of Chinese New Year celebration.

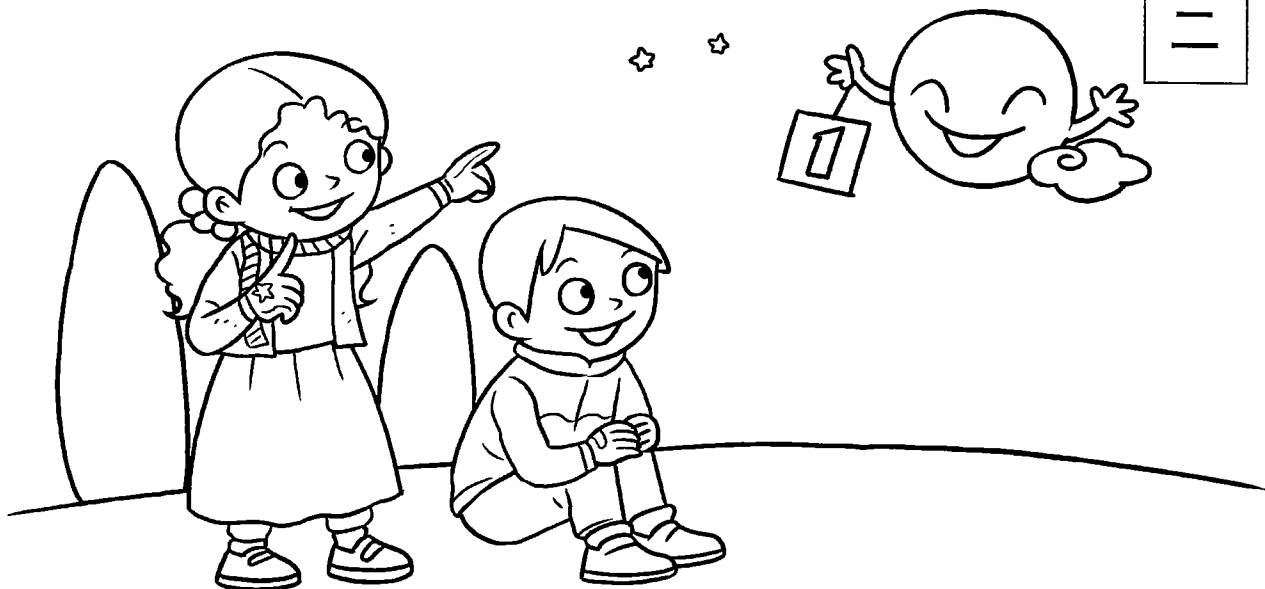

zhè yì tiān shì xīn nián yǐ hòu kàn dào de dì yí gè mǎn yuè
 这一天是新年以后看到的第一个满月。

On this day, we see the first f_____ m_____ of the New Year.

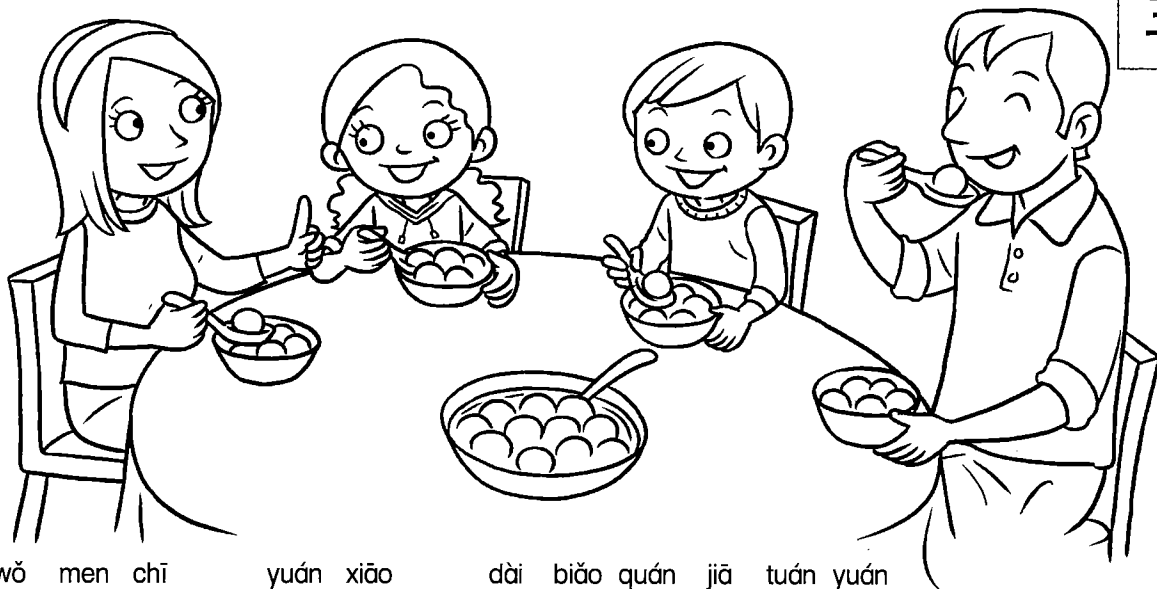

wǒ men chī yuán xiāo dài biǎo quán jiā tuán yuán
 我们吃“元宵”代表全家团圆。

We eat sweet, round dumplings called "_____" to symbolize family togetherness.

四

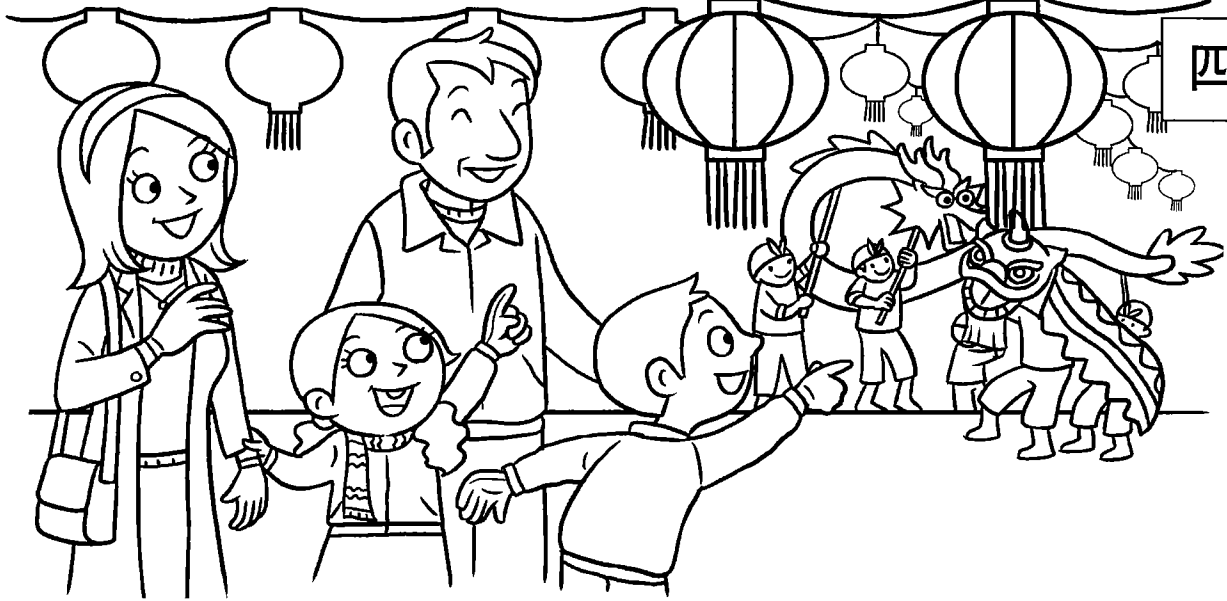

wǒ men shàng jiē qù kàn huā dēng wǔ lóng hé yān huǒ

我们上街去看花灯、舞龙和烟火。

People dress up and head to the street to see | _____ ,
dragon _____ , and f _____ .



五

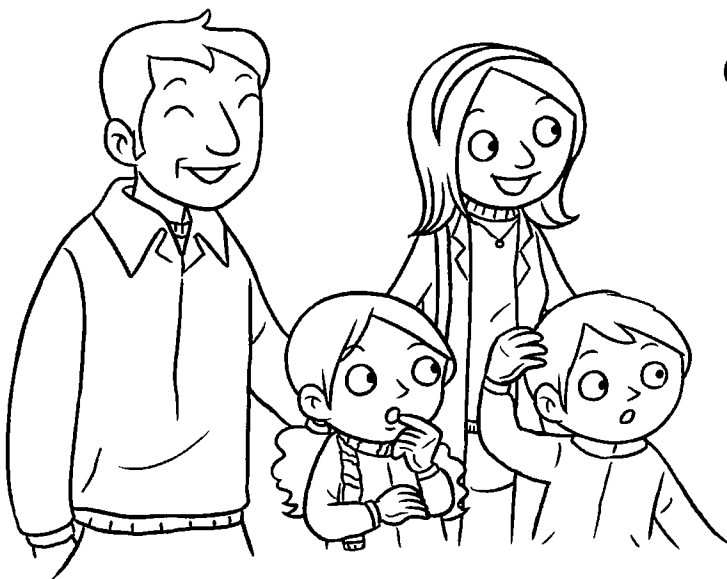

外黄内白，
猴子最爱。

(猜一水果)

Yellow outside,
white inside.
Monkey's favorite
treat. (a fruit)

wǒ men cāi dēng mí zhēn yǒu qù

我们猜灯谜，真有趣。

We guess _____ attached to lanterns. It is a lot of fun for everyone.

Art Project: Chinese Lantern Paper Cut
创意手工：灯笼剪纸

Follow the instructions below to make this paper cut.

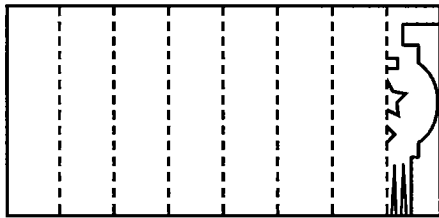
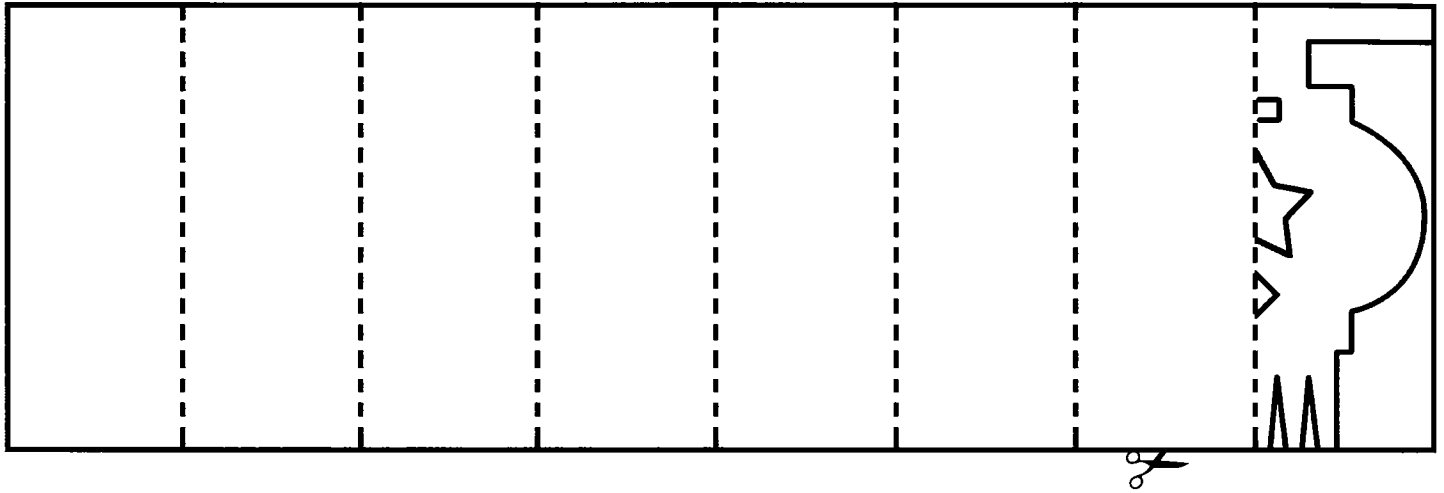

1. Cut out the whole piece of paper.

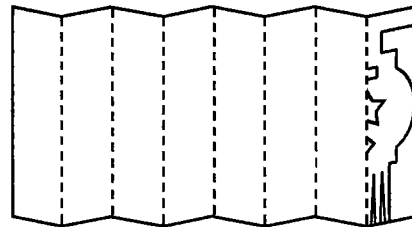

2. Fold along the dotted lines.



3. Maintaining the folds, cut out the shape of the lantern.

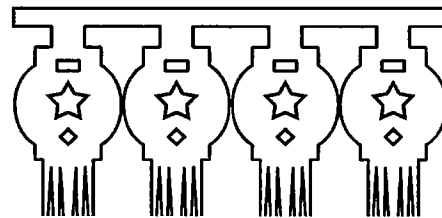

4. Unfold the paper to get the Chinese lantern paper cut.

Art Project: Chinese New Year Lantern
创意手工：新年灯笼

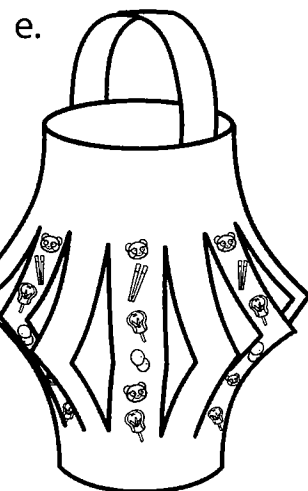
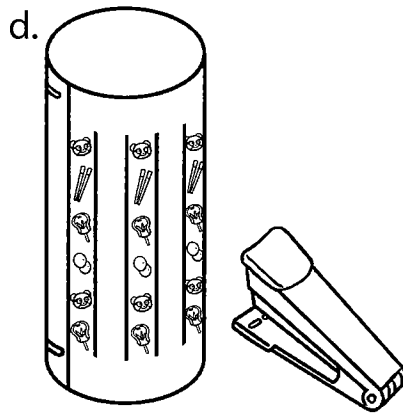
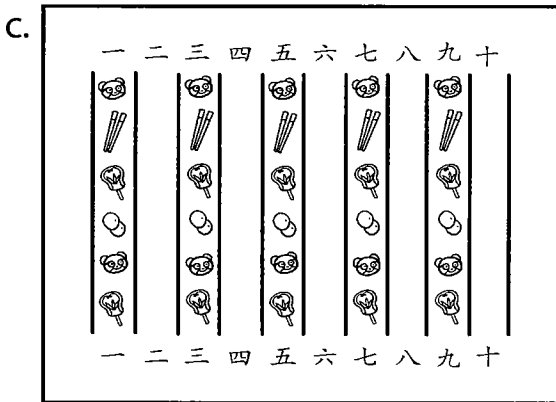
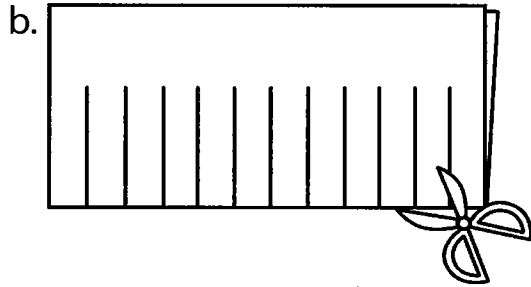
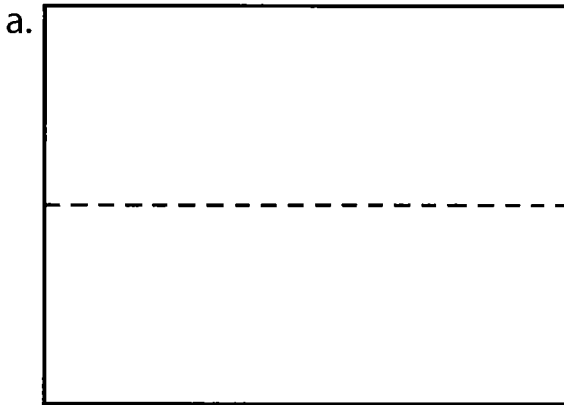

Steps:

1. Fold a rectangular piece of red construction paper lengthwise. (Figure a)
2. Make about 10-12 cuts from the folded side and leave about 1 inch to the edge of the paper. (Figure b)
3. Unfold it and write numbers 1-10 in Chinese on the top and bottom of the paper between cuts. (Figure c)
4. Decorate alternate cuts with Chinese symbols, such as kites, pandas, dragons, chopsticks, fans, and so on. (Figure c)
5. Roll the paper into a tube with words and decoration facing outward. Staple the edges. (Figure d)
6. Decorate a 6" x 2" strip of construction paper and staple it across one end of the lantern to make a handle. (Figure e)
7. Press the top to make the cut strips protrude outward. (Figure e)

Riddle Game: Riddles for Lantern Festival
猜一猜：趣味灯谜

1. 没根不用种，打开像朵花，
四季都会开。（猜一物）

It can grow but has no roots,
Opens like a flower,
Seen all year round.
(an object)

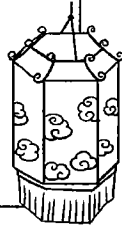

2. 有风不用它，没风可生风，不动不凉，越动越凉。（猜一物）

It is useless when it is windy,
It makes wind when there is none,
When you don't move it, it is not cool,
When you move it, it becomes cool.
(an object)

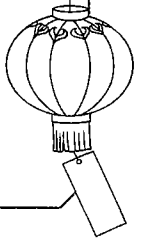

3. 两只脚一样长，
甜酸苦辣一起尝。（猜一物）

It has two feet of the same length.
It takes up everything sweet, sour,
bitter or spicy.
(an object)

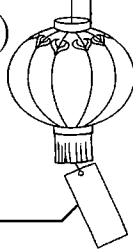

4. 头上几根羽毛，人人拿来玩，
最爱空中跳舞。（猜一物）

It has a few feathers on its head,
Everyone likes to play with it,
It loves to dance in the air.
(an object)

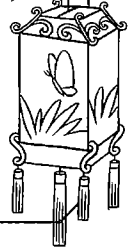

5. 嘴长肚子大，不吃饭和菜，
爱喝白开水，也爱吐黄水。
（猜一日常用品）

Long mouth and big belly; does not eat rice
or vegetables; loves to drink clear water;
yellow water pours from it. (an object)

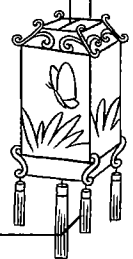

6. 门边贴上红彩衣，一左一右
写满字，喜庆日子便出来。
（猜一物）

Two red strips stuck on two sides of the
door; left and right, each filled with words;
they show up on happy occasions. (an object)

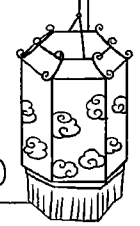

7. 外表绿色，内里空心，
熊猫最爱它。（猜一植物）

Green on the outside,
Hollow on the inside,
Giant Panda's favorite.
(a plant)

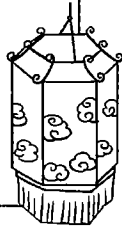

8. 圆形两兄弟，长得一样高，
互追追不到，合作向前走。
（猜一物）

Like two round-shaped brothers; exactly the
same height; always chasing each other; and
working together to move forward. (an object)

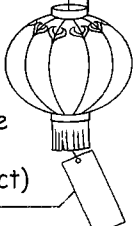

9. 身体用纸造，纸里包住火，
拿着夜行乐趣多。（猜一物）

Its body is made of paper,
Fire fills its inside,
Lots of fun to hold at night.
(an object)

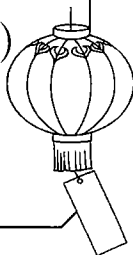

10. 白里透红，生日祝寿。
（猜一食品）

White inside and red outside,
Eaten on birthdays for long life.
(a food)

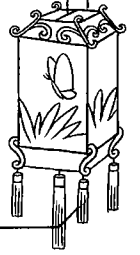

11. 脖子能伸缩，手脚可收藏，
水陆能生存，一生寿命长。
(猜一动物)

Its neck can stretch.
Its feet can hide.
It can survive in water and on land.
It has a long life. (an animal)

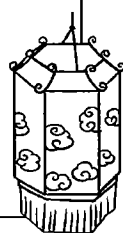

12. 白宝宝，爱吃叶，自筑房子，
人们作衣裳。(猜一昆虫)

It has a white body.
It loves to eat leaves.
It builds its own home.
People use it to make clothes.
(an insect)

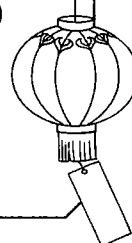

13. 身结红果，引它发火，
声大如雷，好运便来。
(猜一物)

Its body is covered in red; when lit, it
lights up the sky; sounds like loud thunder;
makes good luck come your way. (an object)

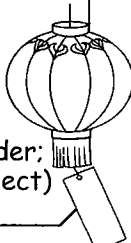

14. 日吃数十斤，初生粉红皮，
渐成黑白衣，圆圆胖胖好
脾气。(猜一动物)

Eats a lot every day; pink when it is
born; gradually turns black and white;
chubby and cheerful. (an animal)

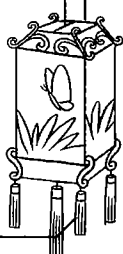

15. 皮制面皮，肚子空心，
不打不发声，越打越欢喜。
(猜一物)

Leather skin. Hollow belly. If you don't
beat it, it has no sound. If you beat it
hard enough, it feels happy. (an object)

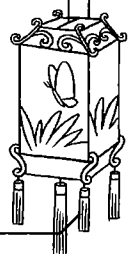

16. 有时像桔子，有时像香蕉，
看得见，摸不到。
(猜一自然景象)

Sometimes it looks like an orange. Sometimes
it looks like a banana. You can see it, but you
cannot touch it. (a natural thing)



17. 兄弟两个，一东一西，
可以听到，不能见到。
(猜一脸上器官)

Two brothers, one right, one left.
They hear each other, but they cannot
see each other. (a sense organ)

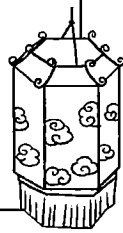

18. 外黄内白，猴子最爱。
(猜一水果)

Yellow outside, white inside.
Monkey's favorite treat.
(a fruit)

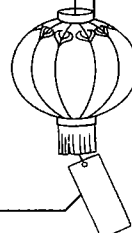

19. 可大可小，可长可短。
只能前进，不能退后。
(猜一抽象物)

They can be big or small, long or short.
They can only go forward. They cannot go
backward. (an abstract concept)



20. 有面没有口，有脚没有手。
虽有四只脚，自己不会走。
(猜一物)

It has a face but no mouth. It has legs
but no hands. Even though it has four
legs, it cannot walk. (an object)

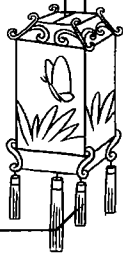

Let's Talk!
说一说

Dialogue 1

(A) 你是哪一年出生的?
nǐ shì nǎ yì nián chū shēng de

(B) 我是_____ 出生的。
wǒ shì _____ chū shēng de

(A) 那你属什么?
nà nǐ shǔ shén me

(B) 我属_____。
wǒ shǔ _____



Dialogue 2

(A) 你最喜欢哪一个生肖?
nǐ zuì xǐ huan nǎ yí gè shēng xiào

(B) 我最喜欢_____。
wǒ zuì xǐ huan _____

(A) 为什么?
wèi shén me

(B) 因为_____。
yīn wèi _____

又_____ 又_____。
yòu _____ yòu _____

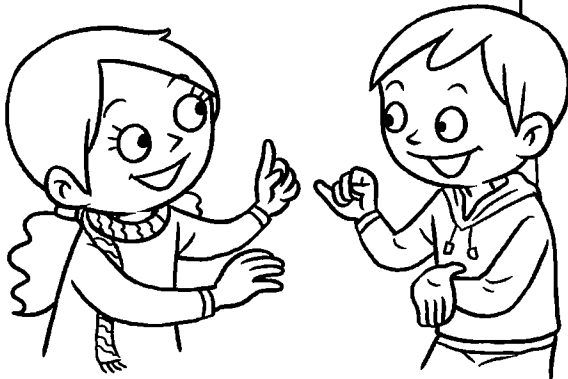

Dialogue 3

(A) 过新年要说什么吉祥话?
guò xīn nián yào shuō shén me jí xiáng huà

(B) 新年快乐! 恭喜发财!
xīn nián kuài lè gōng xǐ fā cái









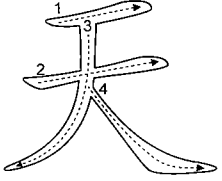

(A) 你要怎么庆祝新年?
nǐ yào zěn me qìng zhù xīn nián

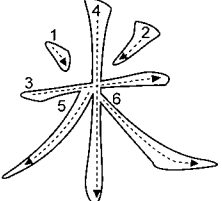
(B) _____

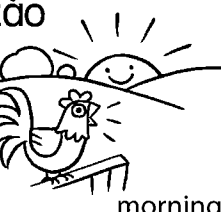
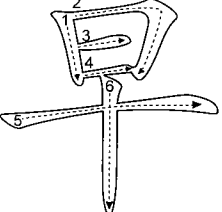
(Mention at least two activities.)

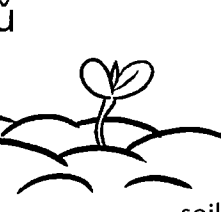
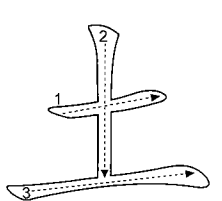

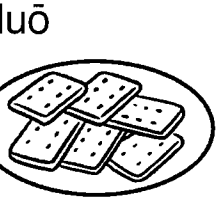
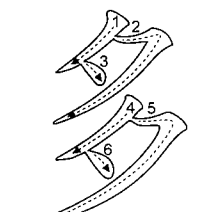
Let's Write!
写一写

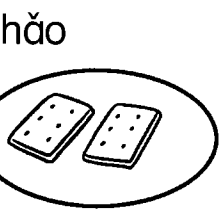
<p>tiān</p>  <p>sky</p>				
<p>mǐ</p>  <p>rice</p>				
<p>zǎo</p>  <p>morning</p>				
<p>tǔ</p>  <p>soil</p>				
<p>duō</p>  <p>more</p>				
<p>shǎo</p>  <p>some</p>	